

**Canon**

**PowerShot G2**

DIGITAL CAMERA

# Camera User Guide



## Flowchart and Reference Guides

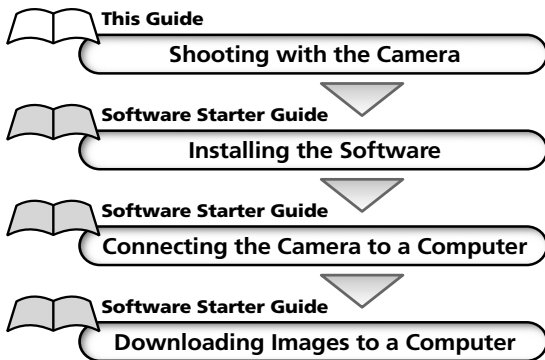

**DPOF**<sup>™</sup>

**DIRECT PRINT**

- Please start by reading the Precaution on the reverse side of this cover.
- For instructions to operate Card Photo Printer CP-10 (optional), please see the User Guide that accompanies it.

**ENGLISH**

## Precaution

### Camera Body Temperature

If your camera is used for prolonged periods, the camera body may become warm. Please be aware of this and take care when operating the camera for an extended period.

### LCD Monitor

The LCD monitor is produced with extremely high-precision manufacturing techniques. More than 99.99% of the pixels operate to specification. Less than 0.01% of the pixels may occasionally misfire or appear as red or black dots. This has no effect on the recorded image and does not constitute a malfunction.

### Video Format

Please set the camera's video signal format to the one used in your region before using it with a TV monitor (p. 119).

Please read the handling and safety precautions starting on page 4 before using the camera.







## Disclaimer















- While every effort has been made to ensure that the information contained in this guide is accurate and complete, no liability can be accepted for any errors or omissions.
- Canon Inc. reserves the right to change the specifications of the hardware and software described herein at any time without prior notice.
- No part of this guide may be reproduced, transmitted, transcribed, stored in a retrieval system, or translated into any language in any form, by any means, without the prior written permission of Canon Inc.
- Canon Inc. makes no warranties for damages resulting from corrupted or lost data due to a mistaken operation or malfunction of the camera, the software, the CompactFlash™ cards (CF cards), personal computers, peripheral devices, or use of non-Canon CF cards.

## Trademark Acknowledgements

- Canon and PowerShot are trademarks of Canon, Inc.
- CompactFlash is a trademark of SanDisk Corporation.
- Other names and products not mentioned above may be registered trademarks or trademarks of their respective companies.

# Table of Contents

Read this First .....	4
Quick Start .....	8
Components Guide .....	10
Front View .....	10
Back View .....	11
Controls .....	12
Main Dial / Mode Dial .....	13
Display Panel .....	15
Preparing the Camera .....	16
Charging the Battery Pack .....	16
Installing the Battery Pack .....	18
Using a Household Power Source .....	20
Using a Charge Adapter / Car Battery Cable Kit (Optional) .....	21
Installing a CF Card .....	24
Setting the Date / Time .....	26
Setting the Language .....	27
Attaching the Strap .....	28
Attaching the Lens Cap .....	28
Using the Soft Case (Optional) .....	28
Basic Functions .....	29
Turning the Power On .....	29
Switching between Shooting and Replaying .....	30
Using the LCD Monitor .....	31
Pressing the Shutter Button .....	36
Using the Optical Viewfinder to shoot .....	37
Adjusting the Zoom .....	38
Selecting Menus and Settings .....	39
Shooting - Letting the Camera Select Settings .....	41
 Auto Mode .....	41
Checking an Image Right after Shooting .....	42
 Using the Built-In Flash .....	43
 Pan Focus Mode .....	46
 Portrait Mode .....	46
 Landscape Mode .....	47
 Night Scene Mode .....	47
 Changing the Color Effect .....	48

 Stitch Assist Mode .....	49
 Movie Mode .....	52
 Macro Mode .....	53
 Self-Timer .....	54
 Continuous Mode .....	55
Digital Zoom .....	57
<b>Shooting - Selecting Particular Effects .....</b>	<b>58</b>
Changing the Resolution and Compression .....	58
Changing the File Format .....	60
<b>P</b> Program AE .....	61
<b>Tv</b> Setting the Shutter Speed .....	62
<b>Av</b> Setting the Aperture .....	64
<b>M</b> Manually Setting the Shutter Speed and Aperture .....	66
 Selecting an AF Frame .....	68
 Adjusting the Exposure Compensation .....	69
<b>WB</b> Setting the White Balance .....	70
 Auto Exposure Bracketing (AEB Mode) .....	73
 Adjusting the Flash Output (Flash Exposure Compensation) ....	74
 Locking the Exposure Setting (AE Lock) .....	75
 Locking the Flash Exposure Setting (FE Lock) .....	77
 Switching between Metering Modes .....	78
Shooting Problem Subjects for the Autofocus .....	80
Switching between Focus Settings .....	82
Manually Setting Image Characteristics .....	83
Resetting the File Number .....	84
Functions Available in Each Shooting Mode .....	85
<b>Replaying .....</b>	<b>86</b>
Viewing Images Singly (Single Image Replay) .....	86
 Magnifying Images .....	87
 Viewing Nine Images at a Time (Index Replay) .....	88
<b>JUMP</b> Jumping between Images .....	89
Viewing Movies .....	90
Rotating Images in the Display .....	91
Automated Playback (Slide Show) .....	92
Protecting Images .....	96
<b>Erasing .....</b>	<b>97</b>
Erasing Images Singly .....	97
Erasing All Images .....	98
Formatting a CF Card .....	99

<b>Print Settings (DPOF Settings)</b> .....	<b>100</b>
Selecting Images for Printing .....	100
Setting the Print Style .....	103
Resetting the Print Settings .....	105
<b>Printing with Card Photo Printer CP-10 (Optional)</b> .....	<b>106</b>
Connecting Card Photo Printer CP-10 to the Camera .....	106
Printing .....	108
Printing with DPOF Print Settings on Card Photo Printer CP-10 .....	112
<b>List of Menu Options</b> .....	<b>114</b>
Rec. Menu .....	114
Play Menu .....	117
Set up Menu .....	118
<b>Shooting / Replaying with a TV Monitor</b> .....	<b>120</b>
<b>Using the Wireless Controller</b> .....	<b>121</b>
Installing the Battery .....	121
Shooting / Replaying .....	122
<b>Using an Externally Mounted Flash (Optional)</b> .....	<b>123</b>
<b>Using Conversion Lenses (Optional)</b> <b>/ Close-up Lenses (Optional)</b> .....	<b>127</b>
Mounting the Lenses .....	128
<b>Appendices</b> .....	<b>130</b>
Replacing the Date Battery .....	130
Camera Care and Maintenance .....	132
Troubleshooting .....	133
List of Error / Message Codes .....	135
List of Messages .....	136
Specifications .....	138
<b>Index</b> .....	<b>143</b>
<b>Canon Customer Support</b> .....	<b>146</b>

### Icon Conventions in the Text



This mark denotes issues that may affect the camera's operation.



This mark denotes additional topics that complement the basic operating procedures.



This mark denotes tips about the camera and photography.

# Read this First

## Please Read

### Test Shots

Before you try to photograph important subjects, we highly recommend that you shoot several trial images to confirm that the camera is operating and being operated correctly. Please note that Canon Inc., its subsidiaries and affiliates, and its distributors are not liable for any consequential damages arising from any malfunction of a camera or accessory, including CompactFlash™ cards, that results in the failure of an image to be recorded or to be recorded in a format that is machine sensible.

### Warning Against Copyright Infringement

Please note that Canon digital cameras are intended for personal use and should never be used in a manner that infringes upon or contravenes international or domestic copyright laws and regulations. Please be advised that in certain cases the copying of images from performances, exhibitions, or commercial properties by means of a camera or other device may contravene copyright or other legal rights even if the image was shot for personal use.

### Warranty Limitations

This camera's warranty is only effective in the country of sale. If a problem arises while the camera is in use abroad, please convey it back to the country of sale before proceeding with a warranty claim to a Canon Customer Support Help Desk.

## Safety Precautions

- Before using the camera, please ensure that you read and understand the safety precautions described below. Always ensure that the camera is operated correctly.
- The safety precautions noted on the following pages are intended to instruct you in the safe and correct operation of the camera and its accessories to prevent injuries or damage to yourself, other persons and equipment.
- In the next few pages, the term "equipment" refers primarily to the camera and its power supply accessories.

## Warnings

- Do not aim the camera directly into the sun or at other intense light sources that could injure your eyesight.
- Do not trigger the flash in close proximity to human or animal eyes. Exposure to the intense light produced by the flash may injure eyesight. In particular, remain at least one meter (39 inches) away from infants when using the flash.
- Store this equipment out of the reach of children and infants. Accidental damage to the camera or batteries by a child could result in serious injury. In addition, placement of the strap around the child's neck could result in asphyxiation.
- Be particularly careful to keep the date batteries used in the camera and wireless controller out of the reach of children. Seek medical assistance immediately if a child swallows a battery.
- Do not attempt to disassemble or alter any part of the equipment that is not expressly described in this guide. Disassembly or alteration may result in high-voltage electrical shock. Internal inspections, alterations and repairs should be conducted by qualified service personnel authorized by your camera distributor or the closest Canon Customer Support Help Desk.
- To avoid the risk of high-voltage electrical shock, do not touch the flash portion of the camera if it has been damaged. Similarly, never touch internal portions of the equipment that become exposed as a result of damage. There is a risk of high-voltage electrical shock. Please take the first opportunity to consult your camera distributor or the closest Canon Customer Support Help Desk.
- Stop operating the equipment immediately if it emits smoke or noxious fumes. Failure to do so may result in fire or electrical shock. Immediately turn the camera's power off, remove the camera battery and unplug the power cord from the electrical outlet. Confirm that smoke or fume emissions have ceased. Please consult your camera distributor or the closest Canon Customer Support Help Desk.
- Stop operating the equipment if it is dropped or the casing is damaged. Failure to do so may result in fire or electrical shock. Immediately turn the camera's power off, remove the camera battery and unplug the power cord from the electrical outlet. Please consult your camera distributor or the closest Canon Customer Support Help Desk.
- Do not allow the equipment to come into contact with, or become immersed in, water or other liquids. Do not allow liquids to enter the interior. The camera has not been waterproofed. If the exterior comes into contact with liquids or salt air, wipe it dry with a soft, absorbent cloth. If water or other foreign substances enter the interior, immediately turn the camera's power off and remove the camera battery or unplug the power cord from the electrical outlet. Continued use of the equipment may result in fire or electrical shock. Please consult your camera distributor or the closest Canon Customer Support Help Desk.

- 
- Do not use substances containing alcohol, benzene, thinners or other flammable substances to clean or maintain the equipment. The use of these substances may lead to fire.
- 
- Remove the power cord on a regular periodic basis and wipe away the dust and dirt that collects on the plug, the exterior of the electrical outlet and the surround area. In dusty, humid or greasy environments, the dust that collects around the plug over long periods of time may become saturated with humidity and short-circuit, leading to fire.
- 
- Do not cut, damage, alter or place heavy items on the power adapter cord. Any of these actions may cause an electrical short circuit, which may lead to fire or electrical shock. Replace a broken or damaged power adapter cord.
- 
- Do not handle the power cord if your hands are wet. Handling it with wet hands may lead to electrical shock. When unplugging the cord, ensure that you hold the solid portion of the plug. Pulling on the flexible portion of the cord may damage or expose the wire and insulation, creating the potential for fires or electrical shocks.
- 
- Use of power sources not expressly recommended for this equipment may lead to overheating, distortion of the equipment, fire, electrical shock or other hazards. Use only the recommended power accessories.
- 
- Do not place the batteries near a heat source or expose them to direct flame or heat. Neither should you immerse them in water. Such exposure may damage the batteries and lead to the leakage of corrosive liquids, fire, electrical shock, explosion or serious injury.
- 
- Do not attempt to disassemble, alter or apply heat to the batteries. There is serious risk of injury due to an explosion. Immediately flush with water any area of the body - including the eyes and mouth, or clothing - that comes into contact with the inner contents of a battery. If the eyes or mouth contact these substances, immediately flush with water and seek medical assistance.
- 
- Avoid dropping or subjecting the batteries to severe impacts that could damage the casings. It could lead to leakage and injury.
- 
- Do not short-circuit the battery terminals with metallic objects, such as key holders. It could lead to overheating, burns and other injuries. Use the supplied terminal cover to transport or store the battery pack.
- 
- Before you discard a battery, cover the terminals with tape or other insulators to prevent direct contact with other objects. Contact with the metallic components of other materials in waste containers may lead to fire or explosions. Discard the batteries in specialized waste facilities if available in your area.
- 
- Use of batteries not expressly recommended for this equipment may cause explosions or leaks, resulting in fire, injury and damage to the surroundings. Use only recommended batteries and accessories.
- 
- Disconnect the compact power adapter from both the camera and electrical outlet after recharging and when the camera is not in use to avoid fires and other hazards. Continuous use over a long period of time may cause the unit to overheat and distort, resulting in fire.
-



- 
- The camera terminal of the supplied compact power cord is designed for exclusive use with your camera. Do not use it with other products or batteries. There is a risk of fire and other hazards.
- 
- Exercise due caution when screwing on the separately sold wide converter lens, tele-converter lens, close-up lens and conversion lens adapter. If they loosen, fall off and shatter, the glass shards may cause an injury. Never aim the lenses at the sun or strong light sources. There is a risk of damage to eyesight.

### **Cautions**

- Avoid using, placing or storing the equipment in places subject to strong sunlight or high temperatures, such as the dashboard or trunk (boot) of a car. Exposure to intense sunlight and heat may cause the batteries to leak, overheat or explode, resulting in fire, burns or other injuries. High temperatures may also cause deformation of the casing. Ensure that there is good ventilation when using the compact power adapter to charge the battery pack or power the camera.
- 
- Do not store the equipment in humid or dusty areas. Storage in such areas could lead to fire, electrical shock or other damage.
- 
- Be careful not to bang the camera or subject it to strong impacts or shocks that could lead to injury or damage the equipment when wearing or holding it by the strap.
- 
- Be careful not to cover the flash with your fingers when shooting. In addition, do not touch the surface of the flash after taking several pictures in rapid succession. Either action could result in burns.
- 
- If your camera is used for prolonged periods, the camera body may become warm. Please take care when operating the camera for extended periods as your hands may experience a burning sensation.

### **Preventing Malfunctions**

#### **Avoid Strong Magnetic Fields**

Never place the camera in close proximity to electric motors or other equipment generating strong electromagnetic fields. Exposure to strong magnetic fields may cause malfunctions or corrupt image data.

#### **Avoid Condensation Related Problems**

Moving the equipment rapidly between hot and cold temperatures may cause condensation (water droplets) to form on its external and internal surfaces. You can avoid this by placing the equipment in an airtight, resealable plastic bag and letting it adjust to temperature changes slowly before removing it from the bag.

#### **If Condensation Forms Inside the Camera**

Stop using the camera immediately if you detect condensation. Continued use may damage the equipment. Remove the CF card and battery or Compact Power Adapter (if connected) from the camera and wait until the moisture evaporates completely before resuming use.

# Quick Start

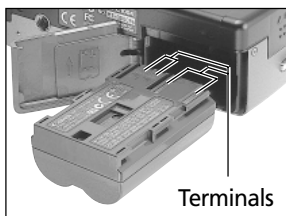

- 1 Install the Battery (p. 18).**  
Slide the battery cover lock, push the battery cover open and insert the battery.

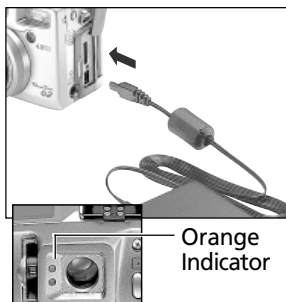

- 2 Charge the Battery (p. 16).**  
Confirm that the main dial (lower dial) is turned to **OFF**. Charge the battery. The battery is approximately 90% charged (adequate charge for use) when the orange indicator beside the viewfinder stops flashing and shines steadily. After charging, detach the compact power adapter's DC plug from the camera.



- 3 Install the CF card. (p. 24).**  
Open the CF card slot and insert a CF card.



- 4 Remove the lens cap.**

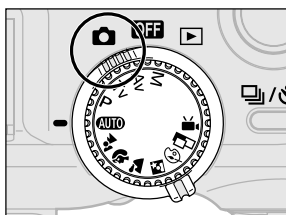

- 5 Turn the power on (p. 29).**  
Open the LCD monitor and turn the main dial (lower dial) to  (shooting).

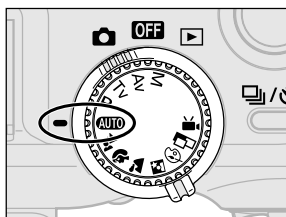

**6** Turn the mode dial (upper dial) to **AUTO** (p. 41).

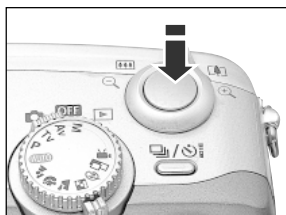

**7** Compose the picture and focus (p. 36).  
Aim the camera and lightly press the shutter button halfway. Two beeps will sound when the autofocus is set.

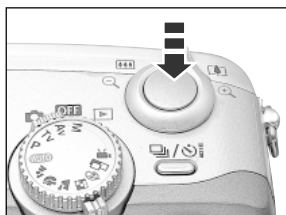

**8** Shoot (p. 36).  
Press the shutter button all the way. You will hear the sound of the shutter close when the shot is complete.



**9** View the recorded image (p. 42).  
The recorded image will display in the LCD monitor for approximately 2 seconds. Keep your finger on the shutter button or press the Set button while the image is displayed to continue to display the image after the shutter button is released.



### To Immediately Delete the Displayed Image

1. Press the  button while the image is displayed.
2. Confirm that [Erase] is selected and press the **SET** button.



# Components Guide

## Front View

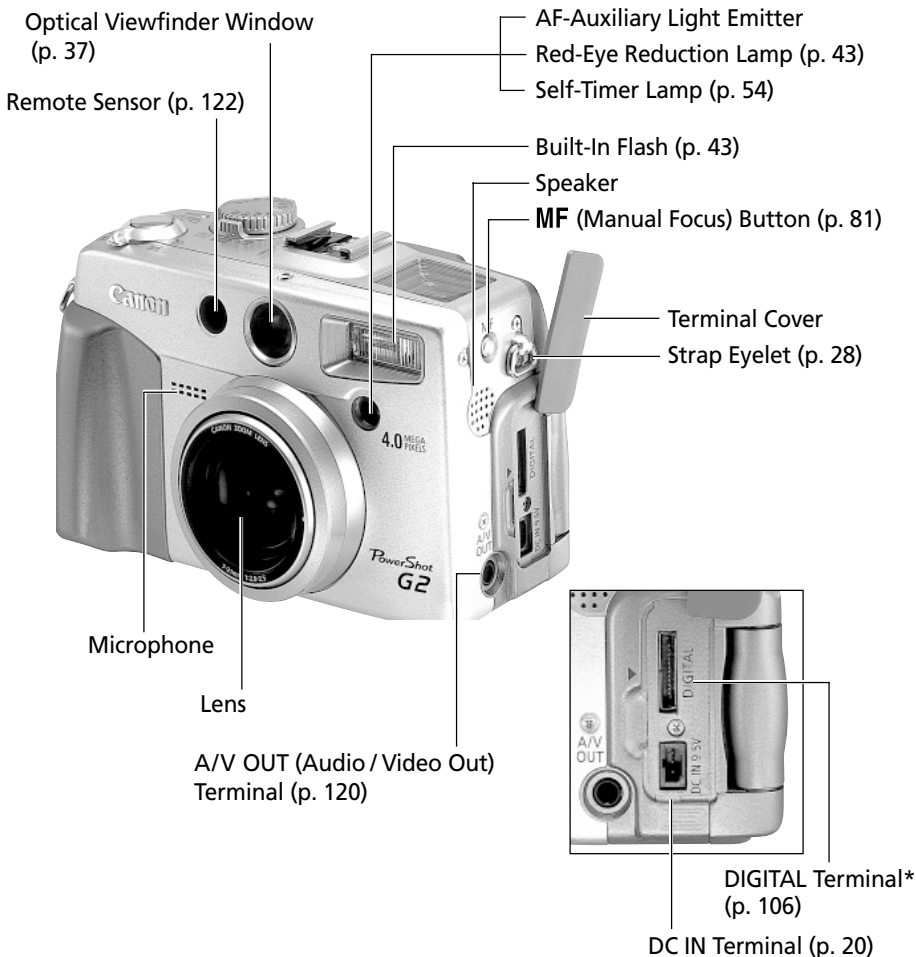

\* To connect the camera to a computer, use the supplied USB cable. To connect it to optional Card Photo Printer CP-10, use Direct Interface Cable DIF-200, which is supplied with the printer.

# Back View

---

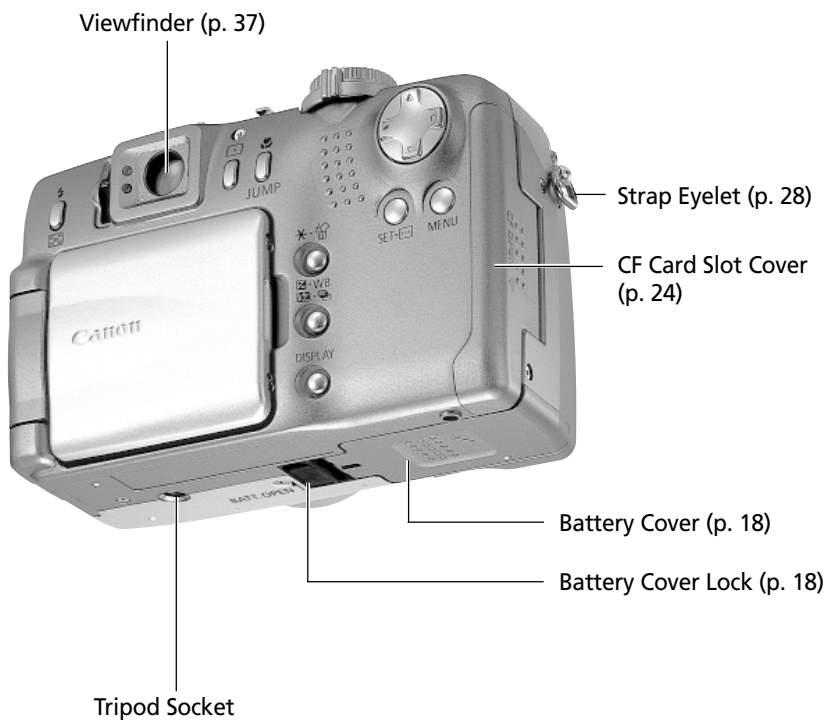

# Controls

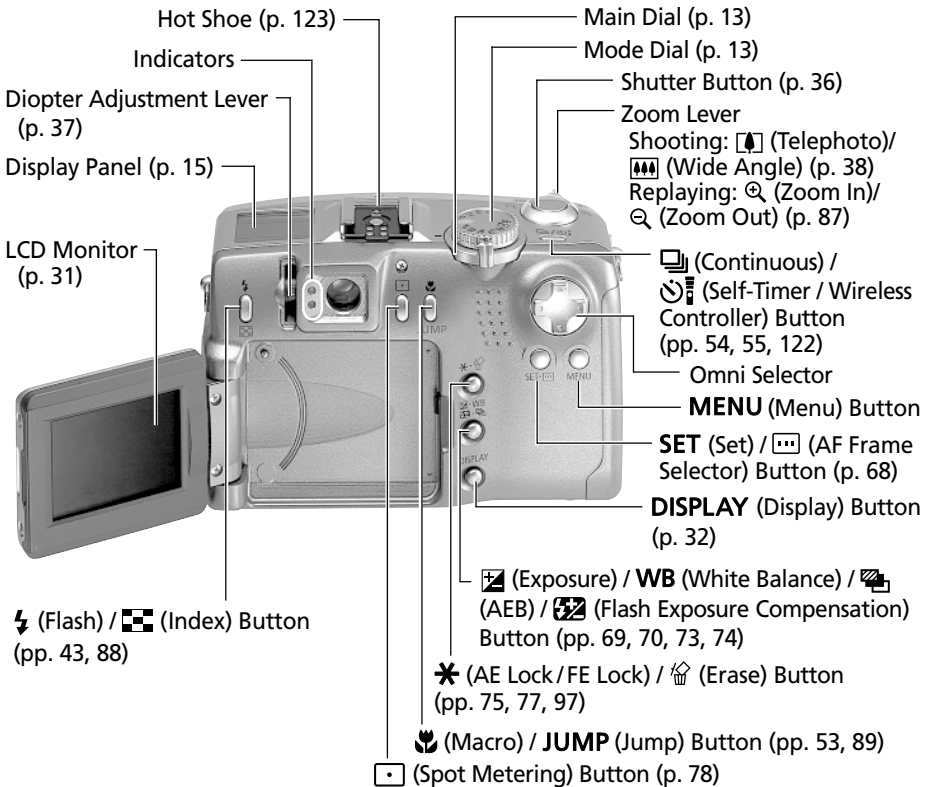

## Indicators

### Upper Indicator

The indicators shine or flash when the shutter button is pressed or the following operations are underway.

- Green: Ready to record / Battery charge complete (100%)\*
  - Flashing Green: Recording to CF card / Reading CF card / Erasing from CF card / Transmitting data (during a computer connection)
  - Orange: Ready to record (flash on) / Battery charge adequate (approx. 90%)\*
  - Flashing Orange: Ready to record (camera shake warning) / Battery is charging (flashing frequency will vary with the charge state)\*
- \* Effective only when attached to the compact power adapter.

### Lower Indicator

- Yellow: Macro mode / Manual focus mode
- Flashing Yellow: Focusing difficulty (although you can press the shutter button, try using a focus lock or adjusting the focus manually, p. 80)

# Main Dial / Mode Dial

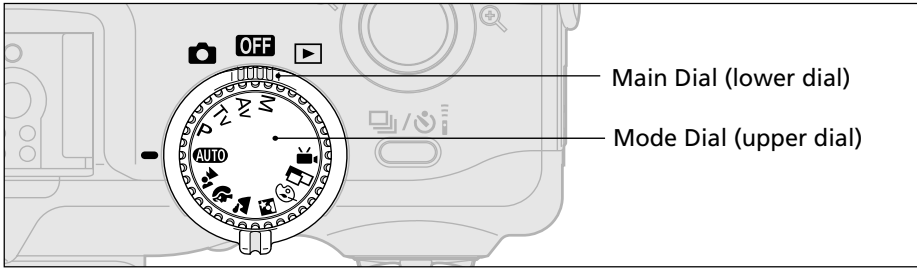

## Main Dial

Use the main dial to switch between the power off, shooting and replaying modes.

**OFF** : Off (p. 29)

**📷** : Shooting (p. 30)

**▶** : Replaying (p. 30)

- The mode used to replay or delete images recorded onto the CF card (p. 31).
- Recorded images can be printed if Card Photo Printer CP-10 (optional) is attached (p.106)
- Recorded images can be displayed on or downloaded to a computer if it is connected

- The  symbol displays in the LCD monitor when a connection is established with Card Photo Printer CP-10.
- PC displays in the LCD monitor when a connection is established with a computer.

## Mode Dial

The mode dial is for selecting a shooting mode when the main dial is set to  (shooting) mode.

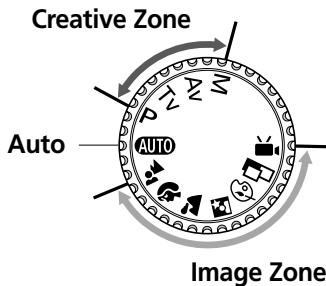







- **AUTO** : Auto (p. 41)

Camera automatically selects settings.

- **Image Zone**

Camera automatically selects settings according to the image composition type.

-  : Pan Focus (p. 46)
-  : Portrait (p. 46)
-  : Landscape (p. 47)
-  : Night Scene (p. 47)
-  : Color Effects (p. 48)
-  : Stitch Assist (p. 49)
-  : Movie (p. 52)

- **Creative Zone**

User selects exposure, aperture or other settings to achieve special effects.

- P** : Program AE (p. 61)
- Tv** : Shutter Speed-Priority AE (p. 62)
- Av** : Aperture-Priority AE (p. 64)
- M** : Manual Exposure (p. 66)



# Display Panel

The display panel shows the camera settings, the remaining image capacity, movie shooting time, battery charge and other information.

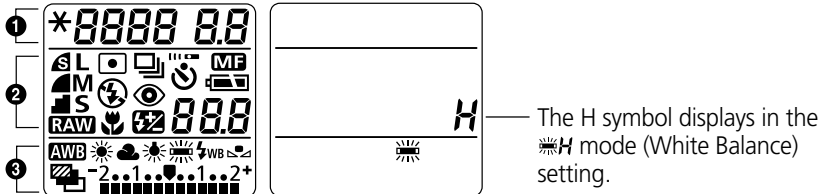

①	*	AE Lock / FE Lock	pp. 75, 77
	8888	Shutter Speed / Movie Shooting Time	-
	8.8	Aperture Setting	-
②		Compression	p. 58
	L LM M S	Resolution	p. 58
	RAW	File Format	p. 60
		Spot Metering	p. 78
		Single Shot / Continuous Mode	p. 55
		Flash On / Flash Off	p. 43
		Red-Eye Reduction	p. 43
		Macro Mode	p. 53
		Flash Exposure Compensation	p. 74
		Self-Timer / Wireless Controller	pp. 54, 122
	MF	Manual Focus	p. 81
		Battery Charge State	p. 18
888	Remaining Image Capacity / Message Code / Error Code	p. 136	
③	AWB     H	White Balance Settings	p. 70
		AEB	p. 73
	-2..1..0..1..2+ 	Exposure Compensation Level / AEB Level / Flash Exposure Compensation Level	pp. 69, 73, 74



- The diagram above shows all the icons appearing at once. Normally, only the icons applicable to the selected mode and camera state appear.

# Preparing the Camera

## Charging the Battery Pack

Use the following procedures to charge the battery pack the first time and subsequently when the low battery icon (🔋) and Lb (Lb) message flash.

**1** Turn the main dial to **OFF**.

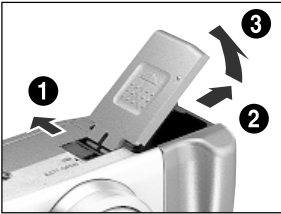

**2** Slide the battery cover lock in the direction of the arrow and open the battery cover.

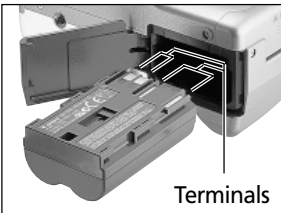

**3** Insert Battery Pack BP-511 and close the battery cover.

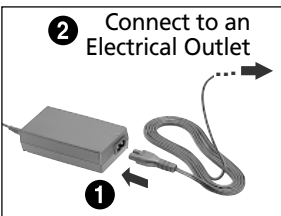

**4** Attach the power cord to the compact power adapter and plug it into an electrical outlet.

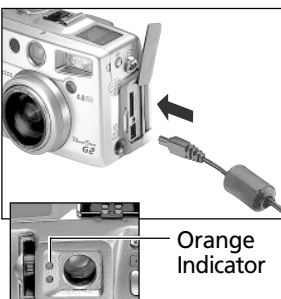

**5** Connect the DC plug of the compact power adapter to the camera's DC IN terminal.

- The indicator beside the viewfinder will flash orange while the battery pack is charging and change to steady orange when it is approximately 90% charged, which is adequate for use. If it is charged for approximately 2 more hours, it will become fully charged and the indicator will switch to green.



- After charging the battery, remove it from the camera if the camera will not be used.



- If the main dial is set to any position other than **OFF** while charging, the battery pack will stop charging and the household electrical current will power the camera.
- This is a lithium ion battery pack so there is no need to completely use or discharge it before recharging. It can be charged at any charge state.
- It takes approximately 80 minutes to bring a fully discharged battery pack to a charge state of approximately 90% (adequate charge for use). It takes approximately 2 more hours to charge it fully (based on standard Canon testing criteria). Charge it within a temperature range of 5 to 40° C (41 to 104° F).
- Charging times will vary according to the surrounding humidity and battery pack charge state.
- Battery Pack BP-512 (optional) can also be used in this camera.

### Battery Pack Handling Precautions

- Keep the battery pack and camera terminals (⊕ ⊖ ⊕ ⊖) clean at all times. Dirty terminals may cause a poor contact between the battery pack and camera. Polish the terminals with a tissue or a dry cloth before charging or using the battery pack.
- Do not cover the compact power adapter with anything, such as a tablecloth, cushion or blanket, when it is charging. Heat will build up internally and possibly lead to fire.
- Do not charge batteries other than Battery Pack BP-511 or Battery Pack BP-512 with the supplied equipment. It could damage the camera.
- The battery pack continues to discharge a small amount when left in the camera even with the power turned off. This shortens the battery life. Remove it from the camera, attach the supplied terminal adapter and store it at room temperature (30° C/86° F or less) in a dry place. Charge it before use.
- Even charged battery packs continue to discharge naturally. You are advised to charge the battery on the day of use, or one day before, to ensure a full charge. Since storing a fully charged battery pack for long periods of time (about 1 year) can shorten its lifecycle or affect performance, you are recommended to use the battery pack in the camera until the LB symbol displays and to store it at room temperature (30° C/86° F or less). If you do not use the battery pack for long periods of time, charge it fully and discharge it fully in the camera at least once a year before returning it to storage.
- The camera consumes the battery charge when the power is on even when a function is not being used. To conserve the battery charge, be particularly attentive in turning the power off.
- Although the battery pack's maximum operating range is 0 to 40° C (32 to 104° F), the optimal range is 10 to 30° C (50 to 86° F). At cold temperatures, such as those experienced on ski hills, performance will temporarily decline, reducing the usable time before recharging.
- If the usable time of a battery pack diminishes substantially even when fully charged, it should be replaced.

# Installing the Battery Pack

Install Battery Pack BP-511 (supplied) into the camera as follows. Use a household power source to power the camera for extended periods (p. 20).



**1** Turn the main dial to **OFF**.

**2** Slide the battery cover lock in the direction of the arrow and open the battery cover.

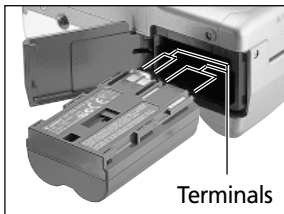

**3** Insert the battery pack as shown.

**4** Close the battery cover.



- Charge the battery pack before using it the first time (p. 16).
- The flashing green indicator signals that the CF card is being written to, read, or erased, or that data is being sent to the computer. Never open the battery cover or remove the battery while it is flashing.
- Remove the battery pack when the camera is not in use.



## Battery Status Symbols

- The following icons indicate the battery status. These icons will not appear while the camera is plugged into a household power source.

 (Steady): Sufficient battery charge

 (Flashing): Low battery

 (Flashing): Replace or recharge battery

## Battery Performance

	Number of Images Shot		Replay Time
	LCD Monitor On	LCD Monitor Off	
Battery Pack BP-511/BP-512 (full charged)	Approx. 400 images	Approx. 1000 images	Approx. 300 minutes

- The data above reflects standard Canon testing conditions. The actual figures will vary according to the shooting conditions and settings.
- Movie data is excluded.
- At low temperatures, the battery pack performance may diminish and the low battery icon appear very rapidly. In these circumstances, the performance can be improved by warming the battery pack in a pocket before use.

### <Test Conditions>

**Shooting:** Room temperature (23° C, 73° F), alternating maximum wide angle and maximum telephoto shots at 20-second intervals with flash fired once every four shots and camera power turned off and on every eighth shot. CF card used.

**Replaying:** Room temperature (23° C, 73° F), continuous playback at one image per 5 seconds. CF card used.

# Using a Household Power Source

You should use a household power source for long periods of continuous use or for connecting to a computer or Card Photo Printer CP-10 (optional).

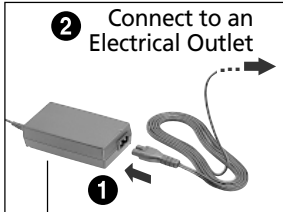

Compact Power Adapter  
CA-560

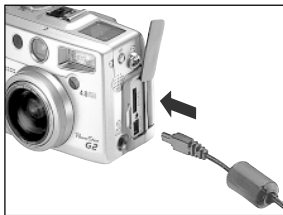

**1** Attach the power cord to the compact power adapter and plug it into an electrical outlet.

**2** Open the terminal cover and connect the DC plug of the compact power adapter to the camera's DC IN terminal.

- Always disconnect and unplug the compact power adapter after use.



- Always turn the camera's power off before connecting or disconnecting the compact power adapter.
- The battery cannot be charged while the compact power adapter is being used to run the camera (main dial is set to any position other than Off).
- Do not use Compact Power Adapter CA-560 with any devices other than those for which Battery Pack BP-511 or Battery Pack BP-512 are specified.

## Using a Charge Adapter / Car Battery Cable Kit (Optional)

Charge Adapter / Car Battery Cable Kit CR-560 (optional) can be used to charge battery packs or to power the camera from a car's cigarette lighter socket. You can also charge Battery Pack BP-511 or Battery Pack BP-512 (optional) from a household power source without using the camera by connecting Compact Power Adapter CA-560 (supplied with the charger adapter) to Charge Adapter / Car Battery Cable Kit CR-560.

### Using a Car Cigarette Lighter Socket as a Power Source

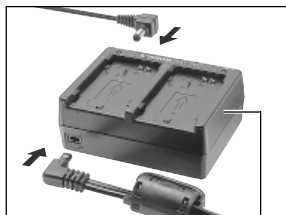

Charge Adapter

- 1** Attach the DC cable and car battery cable to the charge adapter.

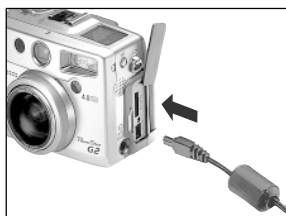

- 2** Connect the DC cable to the camera's DC IN terminal.

- Confirm that the camera's power is turned off.



- 3** With the engine running, plug the car battery cable into the car's cigarette lighter socket.

- Be sure to have the engine running when you unplug it too.

- 4** Turn the camera on.



- Always ensure that the car's engine is running when you use Charge Adapter / Car Battery Cable Kit CR-560. Use of the kit without the engine running may flatten the car battery. Always unplug the kit before turning off the engine.

## Charging the Battery Pack

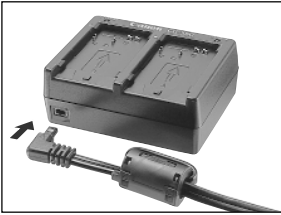

- 1** Attach the car battery cable to the charge adapter.

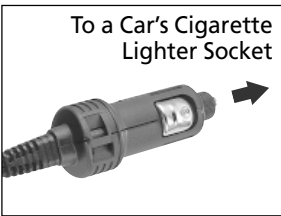

- 2** With the engine running, plug the car battery cable into the cigarette lighter socket.

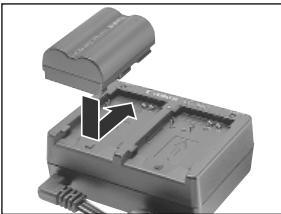

- 3** Attach the battery pack.
  - Align the battery pack with the ▲ mark on the charge adapter and slide it in the direction of the arrow.
  - Up to two Battery Pack BP-511s can be placed in the charge adapter simultaneously.
  - Either slot, A or B, can be used to charge a single battery pack. When two are placed in the charge adapter, the first one to be installed will start charging. The second battery pack will start charging after the first has been fully charged.
  - If two battery packs have been placed in the charge adapter before it is plugged into the cigarette lighter socket, the one placed in the A side will charge first. (B side will start after A side is fully charged.)
  - The red light will flash while a battery pack is charging and shine steady when it is charged.
  - It takes approximately 80 minutes to charge a single battery pack.
- 4** After charging, remove the battery pack.
  - Remove the battery pack by sliding it in the opposite direction from which it was installed.



## 5 With the engine running, unplug the car battery cable from the socket.

- Whenever you turn the engine off, the battery will stop charging, so be sure to unplug the charge adapter from the cigarette lighter socket.
- Wait until the engine is running again to plug it back into the cigarette lighter socket and resume charging.



### Charging with the Compact Power Adapter

- Battery packs can also be charged in the charge adapter using a household power source by attaching Compact Power Adapter CA-560 in place of the car battery cable. This allows you to use the camera while your other battery packs are charging.

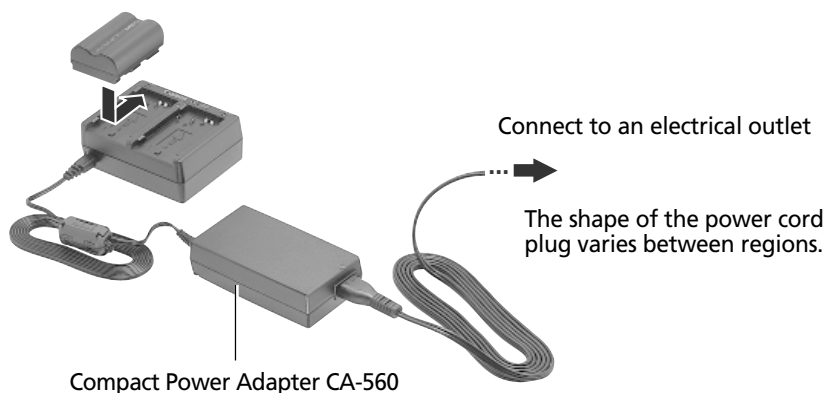

# Installing a CF Card

---

**1** Turn the main dial to **OFF**.

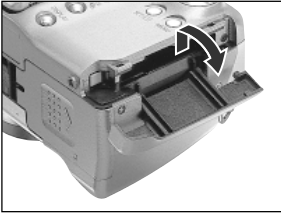

**2** Slide the CF card cover in the direction of the arrow and lift it open.

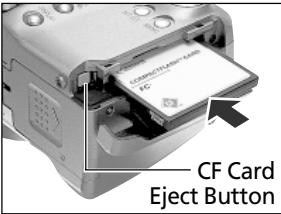















**3** Insert the CF card with the label facing up and the arrow pointing in.

- Push the card in until the CF card eject button fully extends.
- To remove the CF card, push the CF card eject button and pull the card out.







- When the camera's indicator flashes green, the camera is writing, reading, erasing or transmitting an image to or from the card. Do not perform the following, for image data may be lost or corrupted:
  - Subject the camera body to shocks or vibrations
  - Turn off the camera's power or open the battery cover
  - Open the CF card slot cover or remove the CF card
- Never open the CF card slot cover when the power is on.
- Please note that CF cards formatted in or edited with other manufacturer's cameras or application programs may not operate correctly in the camera.

## CF Cards and Estimated Capacities (Recordable Images)

		FC-8M	FC-16M	FC-32M	FC-64M	FC-128M
<b>L</b> (Large) 2272 x 1704 pixels		3	7	14	30	61
		6	13	27	54	110
		13	26	54	110	220
<b>LM</b> (Medium 1) 1600 x 1200 pixels		7	14	30	61	123
		13	26	54	109	219
		26	52	108	217	435
<b>M</b> (Medium 2) 1024 x 768 pixels		12	25	53	107	215
		23	46	94	189	379
		42	84	174	349	700
<b>S</b> (Small) 640 x 480 pixels		29	58	120	241	483
		47	94	196	394	789
		83	165	337	677	1355
<b>RAW</b>	2272 x 1704 pixels	1	4	10	20	42
<b>Movie</b>	 320 x 240 pixels	30 sec.	61 sec.	124 sec.	250 sec.	502 sec.
	 160 x 120 pixels	112 sec.	223 sec.	457 sec.	916 sec.	1834 sec.

\* Figures over 1000 display as "999" since the display panel can only show up to three digits.

- The data above reflects standard Canon testing conditions. The actual figures will vary according to the shooting conditions and settings.
- The following are the approximate maximum recording times for movie clips:  
 30 seconds,  120 seconds. The maximums in the chart reflect continuous shooting.
-  Superfine,  Fine and  Normal indicate the relative compression ratio.

## CF Card Handling Precautions

- CF cards are high-precision electronic devices. Do not bend, force, or subject them to shocks or vibration.
- Do not attempt to disassemble or alter a CF card.
- Moving a CF card rapidly between temperature extremes may cause condensation to form in the card, leading to potential malfunctions. To avoid condensation formation, place the CF card in a sealed plastic bag before moving it into a different temperature zone and allow it to adjust slowly to the new temperature. If condensation forms on the CF card, put it aside until the water droplets have evaporated completely.
- Place the CF card in the supplied case for storage.
- Do not use or store CF cards in the following types of locations.
  - Locations subject to dust or sand
  - Locations subject to high humidity and high temperatures

Microdrives are a recording medium with a hard disk. Their merits are a large capacity and a low price per megabyte of capacity. However, they are relatively more susceptible to vibrations and shocks than CF cards, which use durable flash memories. Please be careful, therefore, not to subject the camera to vibrations or shocks when using a microdrive, especially while recording or replaying.

# Setting the Date/Time

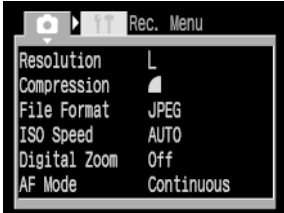

📷 (Rec.) Menu.





- 1 Turn the main dial to 📷 or ▶️.
  - The camera will power up.
- 2 Press the **MENU** button.
  - The [📷 (Rec.)] or [▶️ (Play)] menu will display.
- 3 Press the ▶️ arrow on the omni selector to select the [⚙️ (Set up)] menu.
  - Pressing the **JUMP** button also switches between menus.
- 4 Press the ▲ or ▼ arrow on the omni selector to select [Date/Time], then press the **SET** button.
  - The factory default for the date format may differ from that shown here in some regions.
- 5 Set the date and time.
  - Press the ◀️ or ▶️ arrow on the omni selector to select a field to change.
  - Press the ▲ or ▼ arrow on the omni selector to set the values.
- 6 Press the **SET** button.
  - After adjusting the settings, press the **MENU** button to close the menu window.





- If the Set Date/Time menu appears when the camera is turned on, it means that the date battery (button battery) charge is low and that the settings have been lost. Reset the date and time after you replace the date battery (p. 130).
- The date can be set up to the year 2030.



# Setting the Language

- 1 Turn the main dial to  or .







  - The camera will power up.

- 2 Press the **MENU** button.

  - The  (Rec.) or  (Play) menu will display.

- 3 Press the  arrow on the omni selector to select the  (Set up) menu.

  - Pressing the **JUMP** button also switches between menus.

- 4 Press the  or  arrow on the omni selector to select [Language] and press the **SET** button.
- 5 Press the , ,  or  arrow on the omni selector to select a language.
- 6 Press the **SET** button.

  - After adjusting the settings, press the **MENU** button to close the menu window.

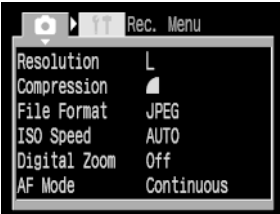

 (Rec.) Menu.

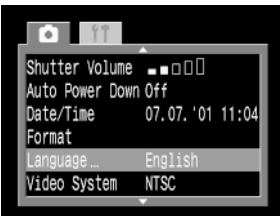

- In replay mode, you can display the language menu by holding the **SET** button while you press the **JUMP** button, except when Card Photo Printer CP-10 (optional) is connected.

## Attaching the Strap

---



Pass the tip of the strap up through the strap eyelet on the camera and then through the bottom of the buckle on the strap. Pull the strap tight in the buckle so that it won't slip. Perform the same steps on the other side of the camera.



- Avoid waving the camera about or catching it on other items when suspending it from the strap.

## Attaching the Lens Cap

---



Fit the lens cap over the lens casing so that it covers the entire lens. Always replace the lens cap after use.



- Attach the lens cap cord to the strap.
- Remove the lens cap before turning on the camera power.

## Using the Soft Case (Optional)

---





The soft case can be used to carry the camera, CF card and the wireless controller.

- Optional soft case appearance and specifications may vary according to region.

# Basic Functions

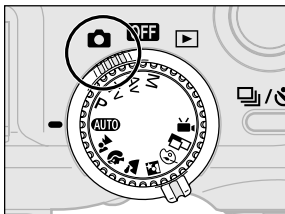
## Turning the Power On



Example of the main dial turned to  (Shooting).

**1** Turn the main dial left or right from the **OFF** position.

- The power is off when the main dial is set to the **OFF** position, and on in any other positions.
- You will hear a startup sound and see the startup window when the power comes on, except when the LCD monitor is closed or shut off, or the PC cable or AV cable is connected. (To adjust the Startup Sound, see p.118)



- **LENS** will appear in the display panel and a warning beep will sound if you turn on the camera with the lens cap on. If this occurs, remove the lens cap and turn the camera off and back on.
- Be careful not to touch the lens when shooting. Please also refrain from forcing the lens with fingers or other objects. It could lead to malfunctions or damage the camera. If the camera will not focus or **LENS** appears in the display panel and a warning beep sounds, turn the camera off and back on.



## Power Save Function

The camera features a power save function that turns the camera off under the following conditions when it is set to on.

**Shooting Mode:** powers down approximately 3 minutes after a control is last accessed. The LCD monitor will shut off approximately 3 minutes after a control is last accessed even if the power save function is turned off.

**Replaying Mode:** powers down approximately 5 minutes after a control is last accessed.

**Card Photo Printer CP-10 (optional) Connection:** powers down approximately 5 minutes after a control is last accessed on the camera or something is printed on the printer.

**PC Connection:** (The power save function always activates regardless of its on/off setting when the camera is battery powered. It will not activate when the camera is powered from a household power source.)

displays a warning message on the computer screen approximately 5 minutes after a control is last accessed. The camera will power down if no controls are used after 1 additional minute.

- Pressing the shutter button halfway will restore power when the camera shuts down with the power save function.
- Please note that the camera continues to consume a minimal amount of power even when the power save function shuts it down.
- The power save function is disabled while a slide show plays on the camera (p. 86).
- You can turn off the power save function in the Set up menu (p. 104).

## Switching between Shooting and Replaying

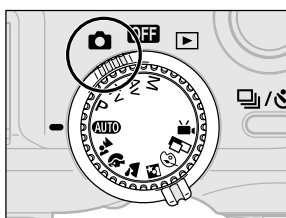

### Shooting

- Turn the main dial to .

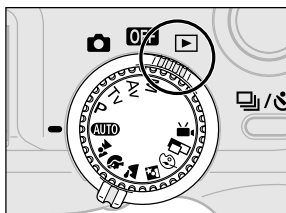

### Replaying

- Open the LCD monitor and turn the main dial to . If you switch rapidly to replay mode directly from shooting mode, the lens may not retract. This is convenient when you wish to shoot again after checking or deleting an image immediately after it is shot.
- Be careful not to touch the lens while in replay mode.



# Using the LCD Monitor

The LCD monitor can be used to confirm an image during shooting, to replay recorded images or to adjust menu settings. It can be opened to the following range of positions.

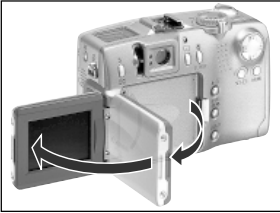

- Opened left to right 180 degrees. It locks temporarily at 90 degrees.



- Tilted forward 180 degrees toward the lens or backward 90 degrees.



- The LCD monitor will automatically turn off when it clicks shut against the camera body. For protection, always close the LCD monitor after use.

## Notice Concerning Shooting

When using this camera to shoot scenes containing extremely bright subjects, a vertical, red bar of light may appear on the LCD monitor. It will not be recorded when shooting still photos, but will be when shooting movies. This is a normal occurrence in devices containing CCDs and does not constitute a malfunction.



- Prevent the DC cable from touching the LCD monitor when the camera is connected to a household power source.

The LCD monitor can also be positioned as below.

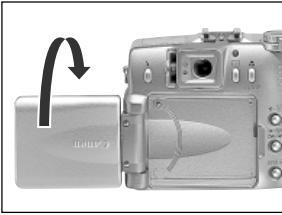

## 1 Open the LCD monitor left 180 degrees and tilt it 180 degrees toward the lens.

- In this position, icons and messages do not appear on the LCD monitor.
- The image shown on the LCD monitor is automatically flipped and reversed so that it appears correctly from in front of the lens.

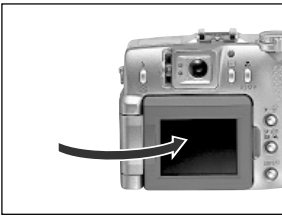

## 2 Fold the LCD monitor back against the camera body.

- Fold it until it clicks into place against the camera body. If it is not fully closed, the image will appear reversed and icons and messages will not display.
- Icons and messages will appear and images will show properly (not reversed) when the LCD monitor is folded right against the camera until it clicks.





## Switching between Display Modes

Pressing the **DISPLAY** button switches the LCD monitor display mode.

### Shooting

- Each time the Display button is pressed, the LCD monitor cycles to the next mode in the following order: display on (no information) → display on (information view) → display off.
- You can also set the LCD monitor display settings in the shooting mode while an image is being reviewed right after being taken by first pressing the **SET** button and then the **DISPLAY** button.



- The display mode is memorized when the camera is turned off. It assumes the last mode when it is turned on again. When the LCD monitor is used for shooting and the low battery icon  appears, however, the LCD monitor may not automatically turn on the next time the camera is started.
- Changing the shooting mode will cause the LCD monitor to display relevant information for about six seconds when it is turned on regardless of whether the information view mode is on or off.
- Setting the mode dial to ,  or  turns on the LCD monitor regardless of whether it is set to on or off.



- The camera shake warning icon will appear at the center of the LCD monitor in low light conditions while the camera is preparing to shoot. When this icon appears, use the flash or fix the camera to a tripod to shoot.

## ▶ Replaying

- The LCD monitor turns on when the main dial is turned to
- Pressing the **DISPLAY** button switches the information view mode.  
Single Replay: Simple Display → Detailed Display → No Display  
Index Replay: Simple Display ↔ No Display

## Information Displayed on the LCD Monitor

The LCD monitor displays information in the shooting or replaying mode, such as the camera settings, remaining image capacity and shooting date/time.

## 📷 Shooting

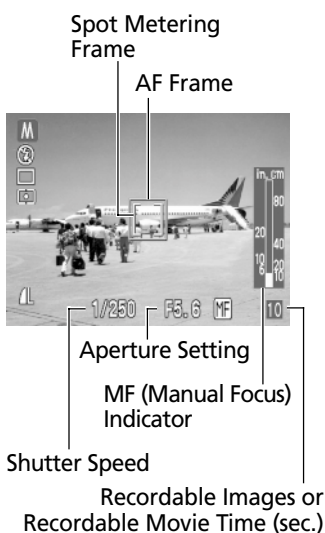

The following displays in information view.

	Shooting Mode	p. 14
	Flash	p. 43
	Drive Mode	pp. 54, 55
	Metering Mode	p. 78
	White Balance	p. 70
-2 ... ±0 ... +2	Exposure Level	p. 69
	AEB Mode	p. 73
	Flash Exposure Compensation	p. 74
	Compression Settings	p. 58
<b>L M1 M2 S 1320 160</b>	Resolution Settings	p. 58
<b>RAW</b>	File Format	p. 60
	AE Lock / FE Lock	pp. 75, 77
	Movie Recording Mode	p. 52
	Macro Mode	p. 53
<b>MF</b>	Manual Focus	p. 81
<b>4.3x 5.3x 6.7x 8.2x 11x</b>	Zoom Power*	p. 57
	Camera Shake Warning	p. 33
	Low Battery	p. 16

- The appearance of icons in the display panel and LCD monitor may differ.
  - The icons in the shaded boxes above display even when the LCD monitor's information view is turned off.
  - In addition to the above, the AF frame, spot metering frame, shutter speed, aperture setting and MF indicator (when manual focus is selected), are displayed as in the example to the left.
- \* Zoom powers reflect the combined optical and digital zoom effects. These figures display when the digital zoom is activated.

## ▶ Replaying



In simple display mode, the following information displays.

	Compression Settings	p. 58
<b>L M1 M2 S</b>	Resolution Settings	p. 58
<b>RAW</b>	File Format	p. 60
<b>AVI</b>	Movie	p. 52
	Protection Status	p. 96

- In addition to the above, the file number, image number and shooting date/time are displayed as in the example to the left.

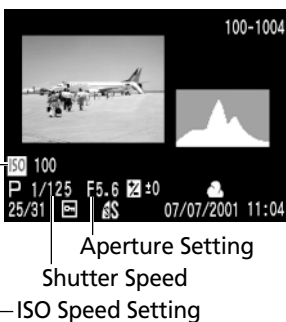

In the detailed display mode, the following information also displays.

	Shooting Mode	p. 14
	Resolution Settings	p. 58
	Exposure Level	p. 69
	White Balance	p. 70
	Metering Mode	p. 78
	Flash Exposure Compensation	p. 74
	Macro Mode	p. 53
<b>MF</b>	Manual Focus	p. 81

- In addition to the above, the ISO speed, shutter speed, aperture setting, histogram and overexposure warning are displayed.



## About the Histogram

The histogram is a graph that allows you to judge the brightness of the recorded image. The greater the bias toward the left in the graph, the darker the image. The greater the bias toward to the right, the brighter the image. If the image is dark, adjust the exposure compensation to a positive number. Similarly, adjust the exposure compensation to a negative number if the image is bright (p. 63).



Dark Image

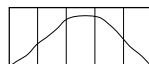

Balanced Image







Bright Image

## Overexposure Warning

In detailed display mode, overexposed portions of the image flash. You can use the histogram as a guide to set the exposure compensation to a negative setting and retake the image.

The following information may also appear with some image files.

	Audio file is attached (wav file).
	An audio file other than a wav file or a file with an unrecognized format is attached.
	A JPEG file not supported by "Design rule for Camera File system" standards.
	A file with an unrecognized format.



- Please note that image information recorded by this camera may not display correctly on other cameras and image information recorded by other cameras may not display correctly on this camera.

# Pressing the Shutter Button

The shutter button features a two-stage action.

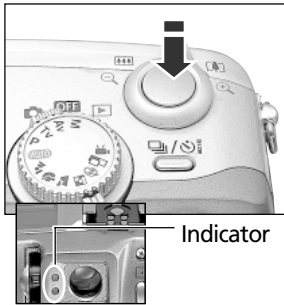

## Pressing Halfway

Pressing halfway automatically sets the exposure, focus and white balance.

- The indicators shine or flash as follows.
    - Green: Metering complete (two beeps sound)
    - Orange: Flash will fire
    - Flashing Orange: Camera shake warning/ Insufficient exposure
    - Yellow: Macro mode/Manual focus mode
    - Flashing Yellow: Focusing difficulty (single beep sounds)
- \*Use the focus lock or focus manually to shoot when the indicator flashes yellow (p. 80).



- The AF frame appears as follows when the LCD monitor is on.
  - Green: Metering complete
  - Yellow: Focusing difficulty

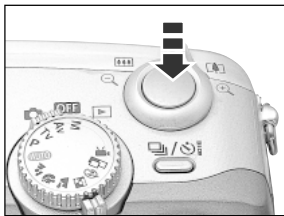

## Pressing Fully

Pressing fully releases the shutter.

- You will hear the shutter sound when the shot is complete. Do not move the camera until you hear this sound. The upper indicator will flash green while the image is recording onto the CF card.



- If the orange or yellow indicator flashes while you press halfway, you can still press fully to take the shot.
- Images are first saved into the camera's internal memory before being recorded onto the CF card, allowing the next images to be taken immediately as long as sufficient space is available in the internal memory.
- The beep and shutter sound can be set On / Off in the Set up menu (p. 118).
- When the shutter sound is set to Off, but the beep is set to On, one beep will sound when the shutter button is fully pressed.
- There is no shutter sound in movie mode.

# Using the Optical Viewfinder to Shoot

The camera is equipped with an optical viewfinder.

---

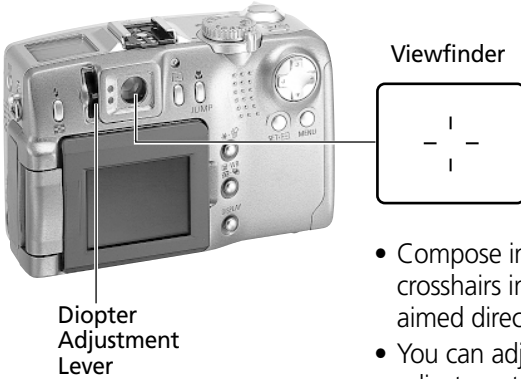

- Compose images so that the autofocus crosshairs in the center of the viewfinder is aimed directly at the subject.
- You can adjust the viewfinder with the diopter adjustment lever to adapt to your vision so that the subject appears in crisp focus.
- The viewfinder has a field of vision of approximately 84%.



## The Parallax Phenomenon

Please note that the actual image may differ from the image seen in the optical viewfinder due to the physical separation between the viewfinder and lens. This is called the parallax phenomenon and is more noticeable the closer the subject is to the lens. In some cases, portions of images shot up close that appear in the viewfinder will not appear in the recorded image. You are recommended to use the LCD monitor to shoot images up close.

## Shooting with an Off-Center AF Frame Selected



You should always use the LCD monitor to compose images when you have selected an off-center AF frame (p. 68).

# Adjusting the Zoom

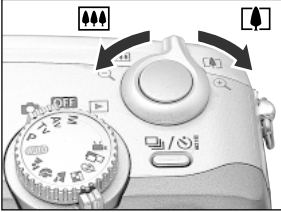
The zoom can be adjusted from 34 mm to 102 mm (equivalent to 35 mm film format).



## Telephoto / Wide Angle



- Press the zoom lever toward  to zoom in (telephoto).
- Press the zoom lever toward  to zoom out (wide angle).



## Digital Zoom

- An image already zoomed with the optical zoom lens can be further zoomed digitally up to an approximate factor of 11 for shooting (p. 57).



- The digital zoom cannot be used with the LCD monitor turned off or in the ,  or  modes.



- The more the image is zoomed digitally, the coarser its image quality becomes.





# Selecting Menus and Settings

Menus are used to adjust shooting, replaying, date / time and beep sound settings. Watch the LCD monitor while performing the following procedures.

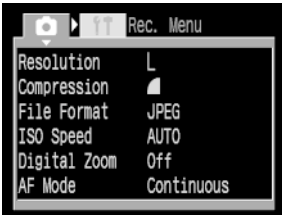
- 1 Press the MENU button.**
  - In  mode, the  (Rec.) menu will appear.  
In  mode, the  (Play) menu will appear.



- 2 Press the ◀ or ▶ arrow on the omni selector to switch between menu tabs.**
  - Pressing the ▶ arrow displays the  (Set up) menu, while the ◀ arrow displays either the  (Rec.) or  (Play) menu.
  - Pressing the JUMP button also switches between the menu tabs.



- 3 Press the ▲ or ▼ arrow on the omni selector to select a menu item.**















- 4 Press the ◀ or ▶ arrow on the omni selector to select setting contents.**
  - Press the SET button for items followed by an ellipsis (...) and then select a setting. Press the SET button again to confirm the setting.

- 5 Press the MENU button.**
  - Pressing the MENU button closes the menu and makes the settings take effect.
  - In shooting mode, the menu can be closed by pressing the shutter button halfway.

# Menu Settings and Factory Defaults

This chart shows the options for each menu and the default settings.

	Menu Item	Available Settings	Reference Page
 <b>Rec. Menu (Red)</b>	Resolution (excluding movies)	<b>L</b> 2272 x 1704* / <b>M1</b> 1600 x 1200 / <b>M2</b> 1024 x 768 / <b>S</b> 640 x 480	p. 58
	Resolution (movies)	 320 x 240 /  160 x 120	p. 58
	Compression	 (Superfine) /  (Fine*) /  (Normal)	p. 58
	File Format	JPEG* / RAW	p. 60
	ISO Speed	50* / 100 / 200 / 400 / AUTO	p. 83
	Digital Zoom	On / Off*	p. 57
	AF Mode <sup>(1)</sup>	Continuous* / Single	p. 82
	Light Metering	 Evaluative metering /  Center-weighted averaging	p. 78
	Spot AE Point	Center* / AF Point	p. 78
	Cont. Shooting	 * / 	p. 55
	Review	Off / 2 sec.* / 10 sec.	p. 42
	File No. Reset	On / Off*	p. 84
	Contrast	- / 0* / +	p. 83
	Sharpness	- / 0* / +	p. 83
Saturation	- / 0* / +	p. 83	
 <b>Play Menu (Blue)</b>	Protect	Turns image protection on and off	p. 96
	Rotate	Rotates the image in the display	p. 91
	Erase all	Erases all images on the CF card	p. 98
	Slide Show	Replays selected images as in a slide show	p. 92
	Print Order	Sets the print settings	p. 100
 <b>Set up Menu (Yellow)</b>	Beep	On* / Off	p. 36
	LCD Brightness	Normal / Bright*	p. 118
	Shutter Volume (Shooting)	Off / 1 / 2* / 3 / 4 / 5	p. 36
	Playback Vol. (Replaying)	Off / 1 / 2 / 3* / 4 / 5	p. 90
	Auto Power Down	On* / Off	p. 118
	Date/Time	Sets the date and time	p. 26
	Format	Formats (initializes) the CF card	p. 99
	Language	► English / Deutsch / Français / Nederlands / Dansk / Suomi / Italiano / Norsk / Svenska / Español / Chinese / Japanese	p. 27
Video System	NTSC / PAL	p. 119	

\* Default values. Default languages and video system settings vary between regions.

<sup>(1)</sup> The setting is set to Single when the optical viewfinder is used without the LCD monitor.

- Some menu items are not available in certain shooting modes.

# Shooting - Letting the Camera Select Settings

## **AUTO** Auto Mode

In this mode, all you have to do is press the shutter button and let the camera do everything else.

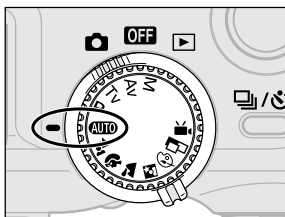

**1** Turn the mode dial to **AUTO**.

**2** Aim the camera at the subject.

**3** Operate the zoom lever to achieve the desired composition (relative subject size in the viewfinder).

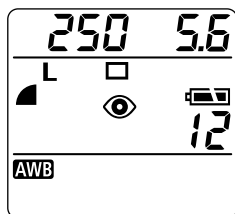

**4** Press the shutter button halfway (p. 36).

- Two beeps will sound when the camera has finished metering and the indicator beside the viewfinder will shine green or orange. If the LCD monitor is on, the AF frame will appear green.
- The shutter speed and aperture settings are automatically determined and show in the display panel. They also appear on the LCD monitor if it is on.
- The yellow indicator will flash and the beep will sound one time if the subject is difficult to focus upon. The AF frame will also appear yellow.









AF Frame

**5** Press the shutter button all the way (p. 36).

- You will hear the sound of the shutter when the shutter activates.
- The picture will appear for 2 seconds in the LCD monitor if it is open.



- You can change the following settings.
  - Resolution: **L** (Large)\* / **M1** (Medium 1) / **M2** (Medium 2) / **S** (Small)
  - Compression:  (Superfine) /  (Fine)\* /  (Normal)
  - Flash:  (Red-Eye Reduction Auto)\* /  (Auto) /  (Off)
  - Drive Method: Single\* / Self-Timer
  - Macro: Off\* / On
  - Digital Zoom: Off\* / On
  - AF Mode: Continuous\* / Single
  - Review: Off / 2 sec\* / 10 sec.
  - File No. Reset: Off\* / On
- \* Default settings
- With the Review function, you can change the length of time images show in the LCD monitor after shooting, or set it so they do not show at all (p. 39).

## Checking an Image Right after Shooting

### Checking the Image

The following explains ways to view the photographed image in addition to viewing it for 2 seconds in the LCD monitor when it has been opened.

### Keeping the Shutter Button Pressed

The image will continue to display in the LCD monitor as long as you keep the shutter button fully depressed.

### Pressing the SET Button

If you press the **SET** button while the image is displayed in the LCD monitor, it will continue to display even after the shutter button is released. Press the shutter button halfway again to stop displaying it.



- You can perform the following while images are displayed.
  - Erasing Images (p. 9)
  - Displaying Images in the Detailed Display Mode (p. 33)
  - Magnifying Images (p. 87)

## Changing the Image Display Duration

The length of time images are displayed with the Review function can be switched from 2 seconds to 10 seconds or off.

**1** In the [📷 (Rec.)] menu, select [Review].

- See Selecting Menus and Settings (p. 39).



**2** Select a Review setting and press the **MENU** button.





- With the [Off] option, the image will not automatically display.
- With the [2 sec.] or [10 sec.] options, the image automatically displays for the set duration even if the shutter button is released.
- You can display the image longer than the 2- or 10-second duration by keeping the shutter button depressed or by pressing the **SET** button while it is displayed.
- Another picture can be taken even while the last is displayed.



- The setting is memorized even when the camera power is turned off.

## ⚡ Using the Built-In Flash

Use the built-in flash according to the guidelines below.

 <b>(Red-eye reduction, Auto)</b>	The flash fires automatically as required by the lighting level, and the red-eye reduction lamp fires each time the main flash fires.
 <b>(Auto)*</b>	The flash fires automatically as required by the lighting level.
 <b>(Red-eye reduction, Flash on)</b>	The red-eye reduction lamp and the flash always fire.
 <b>(Flash on)</b>	The flash always fires.
 <b>(Flash off)</b>	The flash does not fire.

\* No icon appears in the display panel in Auto mode.

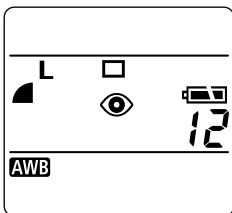

# 1 Press the button to switch between flash modes.













- The selected flash mode will show in the display panel. It will also appear on the LCD monitor if it is on.

# 2 Shoot the image.

- The flash will fire if the indicator beside the viewfinder shines orange when the shutter button is pressed halfway.
- Shooting procedures are the same as for the **AUTO** Auto mode (p. 41).

## Built-in Flash Settings

The flash cannot be used with some shooting modes.

	<b>AUTO</b>								<b>P</b>	<b>Tv</b>	<b>Av</b>	<b>M</b>
 (Red-eye reduction, Auto)	●*	●	●*	●	●*	●	–	–	●	–	–	–
 <sup>A</sup> (Auto)	●	●*	●	●	●	●*	–	–	●	–	–	–
 (Red-eye reduction, Flash on)	–	●	●	●	●	●	–	–	●	●	●	●
 (Flash on)	–	●	●	●	●	●	▲	–	●	●	●	●
 (Flash off)	●	●	●	●*	●	●	▲*	●*	●*	●*	●*	●*

\* Default setting.

● Setting selection is possible.

▲ Setting can only be selected for the first image.

– Setting selection is not possible.



- The fastest shutter speed for flash synchronization is 1/250 second. The camera automatically resets the shutter speed to 1/250 second if a faster speed is selected.
- The flash may take up to approximately 10 seconds to charge in some cases. Actual times will vary according to usage and the battery charge.
- The flash intensity is automatically adjusted except in the **M** mode.
- In the **M** mode, the flash fires at full intensity.
- The flash setting is saved when the camera is turned off in the **P**, **Tv**, **Av** and **M** shooting modes.
- The flash will fire twice. A pre-flash will fire and will be followed by the main flash. The pre-flash is used by the camera to obtain the subject's exposure data so that the main flash can be set to the optimal intensity for the shot.



### **About the Red-Eye Reduction Function**

- Light reflecting back from eyes can make them appear red when the flash is used in dark areas. Under these conditions, use the red-eye reduction mode. For this mode to be effective, the subject must be looking right at the red-eye reduction lamp. Try asking them to look directly at the lamp. Even better results can be obtained by shooting with the lens set to the wide angle, increasing the lighting in indoor settings or approaching closer to the subject.

## Pan Focus Mode

This mode fixes the focus so that shot can be taken quickly when the shutter button is pressed. Use this mode when you do not want to miss a shot, but you cannot predetermine the subject's position or focal distance. The focal length is preset to the maximum wide angle setting.

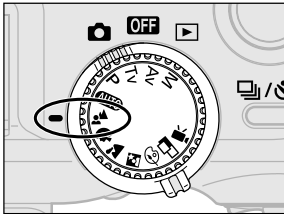

### 1 Turn the mode dial to .

- Shooting procedures are the same as for the **AUTO** Auto mode (p. 41).



- \* The zoom, focus lock, manual focus, macro, AEB, AE lock, FE lock, AF frame, light metering, AF mode, file format (RAW), and image adjustment (ISO speed, contrast, sharpness, and saturation) settings cannot be adjusted in this mode.



- Shots can be taken within the range of 65 cm (25.6 in. ) at maximum wide angle to infinity in this mode.

## Portrait Mode

Use this mode when you want the subject to appear sharp and the background to fade.

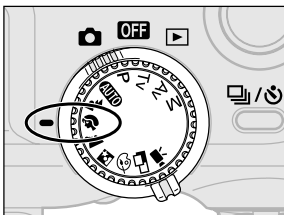

### 1 Turn the mode dial to .

- Shooting procedures are the same as for the **AUTO** Auto mode (p. 41).



- The AEB, AE lock, FE Lock, AF frame, light metering, file format (RAW), and image adjustment (ISO speed, contrast, sharpness and saturation) settings cannot be adjusted in this mode.



- To best achieve the effect of the background gradually fading, compose the image so that the upper half of the subject's body fills most of the viewfinder or LCD monitor.
- The background gets increasingly indistinct the more you adjust the focal length toward telephoto.



## Landscape Mode

Use this mode to shoot expansive landscape scenes.

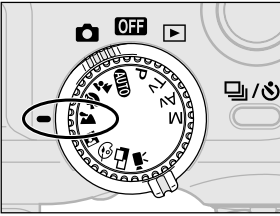



### 1 Turn the mode dial to .

- Shooting procedures are the same as for the **AUTO** Auto mode (p. 41).



- The macro, AEB, AE lock, FE Lock, AF frame, light metering, file format (RAW), and image adjustment (ISO speed, contrast, sharpness and saturation) settings cannot be adjusted in this mode.



- Since a slow shutter speed is often selected in  mode, use a tripod to shoot if the  (camera shake warning) icon appears in the LCD monitor.

## Night Scene Mode

Use this mode to capture human subjects against the backdrop of an evening sky or night scene. The people are illuminated with light from the flash while the backdrop is captured at a slow shutter speed so that both appear correctly exposed.

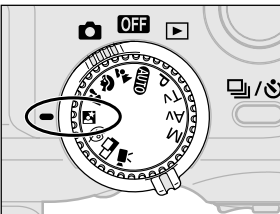



### 1 Turn the mode dial to .

- Shooting procedures are the same as for the **AUTO** Auto mode (p. 41).



- The macro, AEB, AE lock, FE Lock, AF frame, light metering, file format (RAW), and image adjustment (ISO speed, contrast, sharpness and saturation) settings cannot be adjusted in this mode.
- Always use a tripod to prevent camera shake in this mode.



- Warn people to stay still for a few seconds after the flash fires because of the slow shutter speed.
- Optional EX series Speedlites (p. 123) can also be used to shoot in  mode.
- Using the  mode in daylight will produce an effect similar to that of the **AUTO** mode.



# Changing the Color Effect

You can shoot with different color effects.

	<b>(Vivid)</b>	Emphasizes the contrast and color saturation to record in bold color.
	<b>(Neutral)</b>	Tones down the contrast and color saturation to record neutral hues.
	<b>(Sepia)</b>	Records in sepia tones.
	<b>(B/W)</b>	Records in black and white.

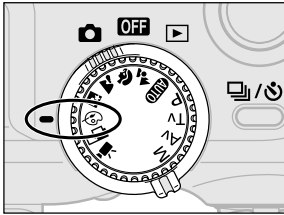

**1** Open the LCD monitor and turn the mode dial to .

- The LCD monitor will turn on and display the color effects menu.



**2** Select a color effect with the ◀ or ▶ arrow of the omni selector.

**3** Press the **SET** button.

- You can also press the shutter button directly to shoot instead of pressing the **SET** button.

**4** Shoot the image.

- Shooting procedures are the same as for the **AUTO** Auto mode (p. 41).
- If you press the **SET** button after shooting, the Setup menu will display and allow you to change the setting again.



- The AEB, AE lock, FE lock, AF frame, light metering, file format (RAW), and image adjustment (ISO speed, contrast, sharpness, and saturation) settings cannot be adjusted in this mode.
- The white balance cannot be set when the (sepia) or (B/W) mode is selected.



# Stitch Assist Mode

Use this mode to shoot a series of overlapping frames for merging (stitching) into a large panoramic image on the computer.

**Horizontal**

**Vertical**

**2 x 2**



- Please use the bundled PhotoStitch program to merge the images on a computer.

## Framing a Subject

PhotoStitch detects the overlapping portions of adjoining images and merges them. When composing shots, try to include a distinctive item (landmark, etc.) in the overlapping portions.





- Compose each frame so that it overlaps 30 to 50% of the adjoining image. Try to keep the vertical misalignment to within 10% of the image height.
- Do not include moving items in the overlap.
- Do not try to stitch images that include both distant and close items. Objects may appear warped or doubled up.



### To Shoot a Distant Subject

As shown below, swivel the camera around its axis to take successive shots.

**Horizontal:**  
swivel left to right  
or vice versa

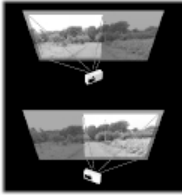

**Vertical:**  
swivel up and down  
or vice versa

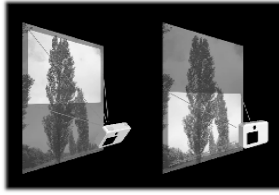

### To Shoot a Close Subject

Slide the camera (move the camera parallel to the subject) to take successive shots.

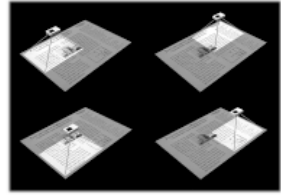

## Shooting

Images can be shot in the following 5 sequences in Stitch Assist mode.

	Horizontally, left to right
	Horizontally, right to left
	Vertically, bottom to top
	Vertically, top to bottom
	Clockwise starting at the top left

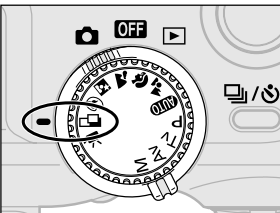

**1** Open the LCD monitor and turn the mode dial to .

- The LCD monitor will turn on.



**2** Select the shooting sequence with the ◀ or ▶ arrow of the omni selector and press the **SET** button.

- You can also press the shutter button directly to shoot instead of pressing the **SET** button.

**3** Shoot the first image.

- The exposure and white balance settings are set and locked with the first image.



Sequence

**4** Compose and shoot the second image so that it overlaps the first.

- Minor discrepancies in the overlap can be corrected with the software.
- An image can be retaken. Press the ◀ or ▶ arrow of the omni selector to return to that frame.

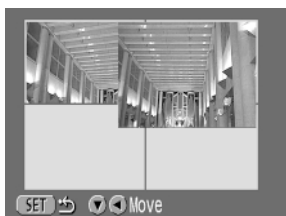

Sequence

**5** Use the same procedures to shoot the remaining frames.

- A maximum of 26 images can be recorded either horizontally or vertically.

**6** Press the **SET** button after the last shot.



- The digital zoom, flash (red-eye reduction auto, auto, red-eye reduction), continuous, AEB, AE lock, FE lock, AF frame, light metering, file format (RAW), and image adjustment (ISO speed, contrast, sharpness, and saturation) settings cannot be adjusted in this mode.
- A TV cannot be used as the monitor for shooting in this mode.





- The zoom, flash (on / off), resolution, exposure, white balance\* and flash exposure compensation settings can only be adjusted for the first image. The selected settings are applied to the subsequent images and cannot be changed.
  - \* A custom white balance setting cannot be set in mode. To use a custom white balance setting, first set it in another shooting mode.
- If you close the LCD monitor while shooting, it will close the Stitch Assist mode session at that point. If you open the LCD monitor again, and attempt to shoot in Stitch Assist mode, it will start a new sequence beginning with image number 1.

## **Movie Mode**

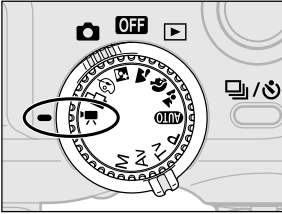
Use this mode to shoot movie frames. You can select between the 320 x 240 (default setting) or 160 x 120 resolution settings in the  (Rec.) menu (p. 58).



- 1 Open the LCD monitor and turn the mode dial to .**
  - The LCD monitor will turn on and display the recordable movie time (seconds).
- 2 Press the shutter button all the way.**
  - Shooting and sound recording will start simultaneously.
  - During the shooting, the elapsed time will show in the display panel and a red circle will appear in the upper right of the LCD monitor.
- 3 Press the shutter button all the way to stop recording the movie.**
  - The maximum length of individual movie clips (approximately 15 frames/second) is about 30 seconds\* at the  setting and about 120 seconds\* at the  setting. The clip will end automatically after this time elapses or when the CF card becomes full.

\* These figures reflect standard shooting conditions established by Canon. Actual times may vary according to the subject and shooting conditions.



- Be careful not to touch the microphone while shooting.
- The AE, AF, white balance, and zoom settings are set and locked to the settings of the first frame.
- If the indicator flashes green after a shoot, this indicates that the movie is being written to the CF card. You cannot shoot until it stops flashing.
- The digital zoom, flash, continuous mode, AEB, flash exposure compensation, AF frame, AE lock, FE Lock, metering method, AF mode (single), compression, file format (RAW), and image adjustment (ISO speed, contrast, sharpness and saturation) settings cannot be adjusted in this mode.



- Sound is recorded monaurally.
- There is no shutter sound in movie mode.





- QuickTime 3.0 or higher is required to replay movie files (AVI / Motion JPEG) on a computer.

## Macro Mode

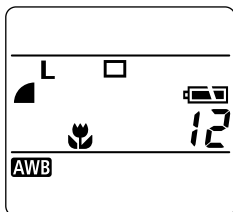
Use the macro mode to shoot close-ups of subjects in the range of 6 to 70 cm (2.4 in. to 2.3 ft.) at maximum wide angle and 20 to 70 cm (7.9 in. to 2.3 ft.) at maximum telephoto.



- 1 Press the **DISPLAY** button.**
  - The LCD monitor will turn on.
- 2 Press the  button.**
  - The  icon will show in the display panel or the LCD monitor.
  - Press the  button again to cancel the macro mode.
- 3 Shoot the image.**
  - The indicator beside the viewfinder will shine yellow when the shutter button is pressed halfway.
  - Shooting procedures are the same as for the **AUTO** Auto mode (p. 41).



- The macro mode cannot be selected in the , , and  shooting modes.
- Please use the separately sold Macro Ring Lite MR-14EX for flash photography in the macro mode. Shoot from a focal distance greater than 20 cm (8 in.). To shoot closer, use the **Av** or **M** mode and set the aperture to a higher value.





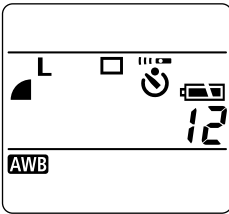

- Always use the LCD monitor to compose images in macro mode. The parallax phenomenon may cause images composed with the optical viewfinder to be off-center.
- When the lens is zoomed to the maximum wide angle, the recordable area is approximately 60 x 82 mm (2.36 x 3.2 in.) at the closest focal distance, and at maximum telephoto, it is approximately 62 x 84 mm (2.44 x 3.2 in.), roughly the size of a business card. If optional Close-up Lens 250D (p. 128) is used in macro mode, the recordable area is approximately 38 x 50 mm (1.5 x 2 in.) at maximum telephoto.
- Turning the camera off cancels the setting.

## Self-Timer

You can take pictures with the self-timer in any shooting mode.



### 1 Press the button.

- Press the  button several times to display the  icon in the display panel. The icon will also appear in the LCD monitor if it is on.
- You can cancel the self-timer by pressing the  button until the  icon disappears.

### 2 Shoot the image.

- When the shutter button is pressed all the way, the self-timer lamp flashes and activates the shutter approximately 10 seconds later. The flashing gets faster 2 seconds before the shutter activates.
- Shooting procedures are the same as for the  Auto mode (p. 37).















- Turning the camera off cancels the setting.



# Continuous Mode

Use this mode to shoot successive frames while the shutter button is pressed fully.



	Use this mode to view the images as you shoot continuously. The shutter interval is longer in this mode than the  mode.
	Use this mode to shoot continuously with a short shutter interval. The camera's internal memory will become full faster in this mode than the  mode when many frames are shot or when high image quality settings are selected.

- 1 Press the  button.**
  - Press the  button several times to display the  icon in the display panel. The icon will also appear in the LCD monitor if it is on.
  - You can cancel the continuous mode by pressing the  button until the  icon disappears.
- 2 In the [Rec.] menu, select [Cont. Shooting].**
  - See Selecting Menus and Settings (p. 35).
- 3 Select  or  and press the **MENU** button.**
- 4 Press the shutter button halfway to lock the focus.**
- 5 Press the shutter button all the way to shoot.**
  - Shooting will cease when the shutter button is released.
  - The shoot speed is approximately 1.5 frames/second\* in  mode and 2.5 frames/second\* in  mode.

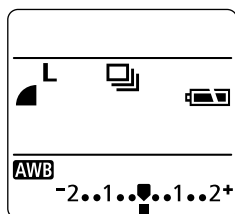
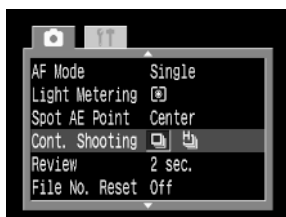
\* Large/Fine, LCD monitor off mode. (These figures reflect standard Canon testing conditions. The actual figures will vary according to the shooting conditions and settings.)





- 
- This mode cannot be selected in the **AUTO**,  or  shooting mode.
  - In **H<sub>1</sub>** mode, images do not appear on the LCD monitor as they are shot.
  - An externally mounted flash will not fire in this mode.
  - The built-in flash can be used, but the interval between images will lengthen to accommodate the flash recharge time.



- 
- Successive frames can be shot until the CF card is filled.
  - The interval between frames may lengthen somewhat when the internal memory gets full.
  - Turning the camera off restores the standard shooting mode. However, the selected continuous shooting option will remain effective the next time continuous shooting is activated, making it possible to skip steps 2 and 3 above if you wish to use the same option.

# Digital Zoom

Images can be zoomed up to approximately 11 times with the combined optical and digital zoom functions.



Zoom Setting



- 1 Press the **DISPLAY** button to turn the LCD monitor on.
- 2 Turn the mode dial to any shooting mode except for , or .
- 3 In the [ (Rec.)] menu, select [Digital Zoom].
  - See Selecting Menus and Settings (p. 39).
- 4 Select [On] and press the **MENU** button.
- 5 Move the zoom lever in the direction of the symbol.
  - The lens will zoom to the maximum optical telephoto setting and stop. Release the lever and move it toward the symbol again. You can further zoom it digitally to 4.3, 5.3, 6.7, 8.2 or 11 times.
  - Move it toward the symbol to zoom back out.
- 6 Shoot the image.
  - Shooting procedures are the same as for the **AUTO** Auto mode (p. 41).



- This mode cannot be selected in the , or shooting modes or for the RAW file format.
- Images become coarser the more they are digitally zoomed.
- The digital zoom On/Off setting is memorized even when the camera power is turned off so you can skip steps 3 and 4 if you wish to use the same option the next time.

# Shooting - Selecting Particular Effects







Camera settings – such as image resolution and compression, shutter speed and aperture – can be freely changed for shooting.





- Please see “Auto Mode” (p. 41) for shooting procedures once you have changed a setting.

## Changing the Resolution and Compression

You can change the resolution and compression (excluding movies) settings to suit the purpose of the image you are about to shoot. The resolution gets higher in the order **S** (Small), **M1** (Medium 1), **M2** (Medium 2), and **L** (Large). Use a higher resolution if you wish to make a large print. Conversely, use a lower resolution if you wish to print on small objects, such as labels, to send images electronically, or to fit more images on a CF card.



The compression gets higher in the order  (Superfine),  (Fine) and  (Normal). Select  (Superfine) for a higher quality image, or  (Normal) if you wish to fit more images on a CF card. The  (Fine) setting provides adequate quality for standard shots. To record the CCD output without compression, select the RAW file format (p. 60).



Resolution		
<b>L</b>	<b>Large</b>	2272 x 1704 pixels
<b>LM (M1)</b>	<b>Medium 1</b>	1600 x 1200 pixels
<b>M (M2)</b>	<b>Medium 2</b>	1024 x 768 pixels
<b>S</b>	<b>Small</b>	640 x 480 pixels

Compression	
	Superfine
	Fine
	Normal

The symbol in brackets ( ) is shown on the LCD monitor.

You can select from among the following resolutions to shoot movies.

Resolution	
	320 x 240 pixels
	160 x 120 pixels

- 1 Turn the mode dial to a shooting mode other than .
- 2 In the [ (Rec.)] menu, select [Resolution] or [Compression].
  - See Selecting Menus and Settings (p. 39).



Resolution (excluding movies)

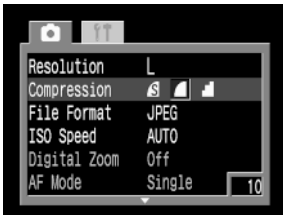

Compression

### 3 Select a resolution or compression setting and press the **MENU** button.

- The number of recordable images or time will display at the bottom right of the menu.

#### Other Modes

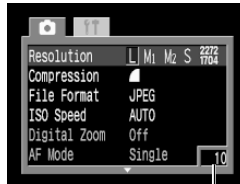

Recordable Images

#### Movie Mode

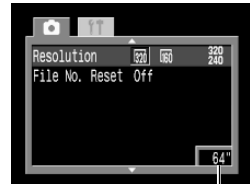

Recordable Movie Time (Sec.)

- The selected resolution and compression settings will show in the display panel.

### 4 Shoot the image.

## Approximate File Size for One Image

Resolution		Compression		
L	2272 x 1704 pixels	2002 KB	1116 KB	556 KB
LM (M1)	1600 x 1200 pixels	1002 KB	558 KB	278 KB
M (M2)	1024 x 768 pixels	570 KB	320 KB	170 KB
S	640 x 480 pixels	249 KB	150 KB	84 KB
RAW	2272 x 1704 pixels	2862 KB		
Movie	320 x 240 pixels	240 KB/sec.		
	160 x 120 pixels	60 KB/sec.		

- This figure reflects standard shooting conditions established by Canon. Actual figures may vary according to the subject and shooting conditions.
- Please see the list of CF cards and their approximate capacities (p. 25).



- In mode, the resolution can be set for the first frame only.
- The resolution and compression settings are affected by the shooting mode selection as follows (only the resolution in mode)

Initial Shooting Mode	Next Shooting Mode	Resolution and Compression after Change
		Settings change to those of the next mode
		Settings do not change
		Settings change to those of the next mode
		Settings do not change
		Settings change to those of the next mode

- The resolution and compression settings are memorized even when the camera power is turned off.

# Changing the File Format

The recording file format can be switched to the RAW format. With the standard JPEG file format, the camera processes images after capturing them to produce optimal results. This format compresses images so that more can be stored on a single CF card. However, the compression is irreversible, meaning that the original image data cannot be recovered after processing. In contrast, the RAW format records the image data as captured by the camera's CCD without further processing. RAW images are compressed, but the compression is reversible\* so that a high-quality image can be obtained from the decompressed file without any loss of image quality. In addition, although a RAW file is larger than an equivalent JPEG file, it is still only approximately one-quarter the size\*\* of an uncompressed RGB TIFF format file, making it relatively compact.

With standard uncompressed file formats, such as RGB TIFF, images are processed in the camera and require further processing by retouching software to adjust the image parameters, which reduces image quality. With the RAW format, however, the original data can be used in special software\* to adjust the image parameters (white balance, contrast, sharpness and saturation) making it possible to maintain the image quality while making changes. The resolution (2272 x 1704) and compression settings cannot be adjusted for these images.

\* The bundled software can be used to open or adjust the parameters of images recorded in the RAW file format. Please consult the Software Starter Guide for details.

\*\* As measured by standard Canon test conditions.

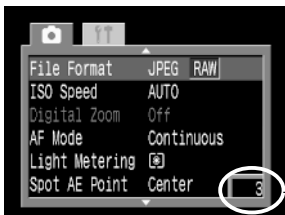

- 1 Turn the mode dial to **P**, **Tv**, **Av** or **M**.
- 2 In the [ (Rec.)] menu, select [File Format].
  - See Selecting Menus and Settings (p. 35).
  - Recordable Images

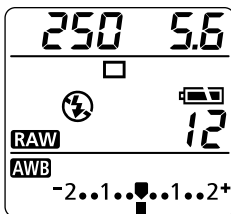

- 3 Select [RAW] and press the **MENU** button.
  - The **RAW** icon will show in the display panel.
- 4 Shoot the image.



- The RAW file format can only be selected in the **P**, **Tv**, **Av** and **M** modes.

# P Program AE

Use the program AE mode to have the camera automatically set the shutter speed and aperture settings to match the brightness of the scene.

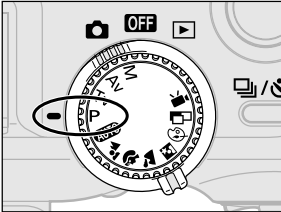

**1** Turn the mode dial to **P**.

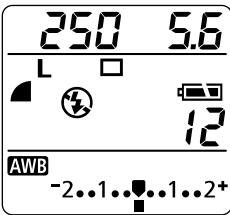

**2** Shoot the image.

- The shutter speed and aperture settings will be set automatically and shown in the display panel. They will also appear in the LCD monitor if it is on.
- The correct exposure has been set if the shutter speed and aperture settings do not blink in the display panel.



- If a correct exposure cannot be obtained, the shutter speed and aperture settings blink in the display panel and show in red in the LCD monitor. Use the following methods to shoot.
  - Use the flash.
  - Adjust the exposure using spot metering, exposure compensation or flash exposure compensation.
  - Switch the shooting mode to **M** (Manual).



## Differences and Similarities between the P and **AUTO** Modes.

- Both modes automatically select the shutter speed and aperture settings.
- The following settings can be adjusted in **P** mode, but not in **AUTO** mode.
  - Exposure Compensation
  - AEB Mode
  - Built-In Flash (Red-Eye Reduction On/On)
  - Continuous Mode
  - Image Adjustment (ISO Speed, Contrast, Sharpness and Saturation) Settings
  - Light Metering Method
  - AF Frame
  - FE Lock
  - White Balance
  - Flash Exposure Compensation
  - File Format Settings
  - Manual Focus
  - AE Lock

# Tv Setting the Shutter Speed

When you set the shutter speed in the shutter speed-priority AE mode, the camera automatically selects an aperture setting to match the brightness. Faster shutter speeds allow you to catch an instantaneous image of a moving subject while slower speeds create a flowing effect and allow you to shoot without a flash in dark areas.

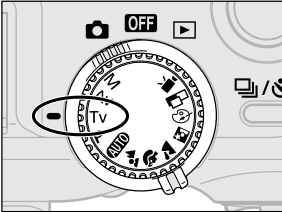

## 1 Turn the mode dial to Tv.

- The shutter speed will show in the display panel. It will also appear on the LCD monitor if it is on.

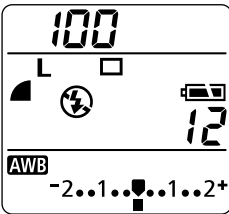

## 2 Press the ◀ or ▶ arrow on the omni selector to select a speed.

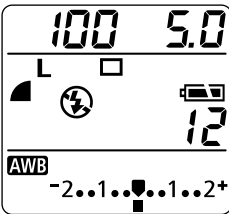

## 3 Shoot the Image.

- The correct exposure has been set if the shutter speed and aperture settings do not blink in the display panel.



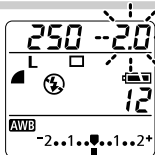

- If the aperture value is flashing in the display panel or shown in red in the LCD monitor, the image is under- or overexposed (insufficient light). Adjust the shutter speed using the ◀ or ▶ arrow on the omni selector until the flashing stops or the aperture value display turns to white.
- The nature of CCD image sensors is such that noise in the recorded image increases at slow shutter speeds. This camera, however, applies special processing to images shot at shutter speeds slower than 1.3 seconds to eliminate the noise, thereby producing high-quality images. Nevertheless, a certain amount of processing time may be required before the next image can be shot.
- The aperture presets to F8.0 when the shutter speed is set to 1/1000 second.



- Please note that camera shake becomes a factor at low shutter speeds. If the camera shake warning  appears in the center of the LCD monitor, secure the camera to a tripod to shoot.

### Shutter Speed Display

The shutter speeds from 1000 to 4 in the display are actually the denominator of a fraction of a second. For example, 160 indicates a speed of 1/160 second. For slower speeds, quote marks indicate the decimal place, so that 0"3 indicates 0.3 second and 2" indicates 2 seconds.

1000	800	640	500	400	320	250	200	160	125	100			
80	60	50	40	30	25	20	15	13	10	8	6	5	4
0"3	0"4	0"5	0"6	0"8	1"	1"3	1"6	2"	2"5	3"2	4"		
5"	6"	8"	10"	13"	15"								

The display of shutter speeds from 1/4 to 1/1000 second differs between the display panel and LCD monitor.

Shutter Speed	1/1000 sec.	1/4 sec.	0.8 sec.	15 sec.
Display Panel	1000	4	0"8	15"
LCD Monitor	1/1000	1/4	0"8	15"

# Av Setting the Aperture

When you set the aperture in the aperture-priority AE mode, the camera automatically selects a shutter speed to match the brightness. Selecting a lower aperture value (opening the aperture) allows you to fade the background and create a beautiful portrait. A higher aperture value (closing it) brings the entire range from foreground to background into focus. The larger the aperture value, the greater the range of the image brought into clear focus.

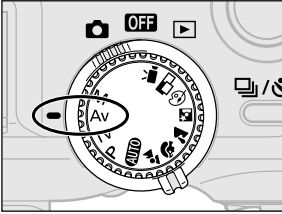

- 1 Turn the mode dial to Av.**
  - The aperture setting will show in the display panel. It will also appear on the LCD monitor if it is on.

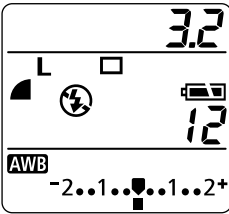

- 2 Press the ◀ or ▶ arrow on the omni selector to select a value.**

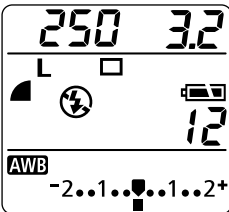

- 3 Shoot the image.**
  - The correct exposure has been set if the shutter speed and aperture settings do not blink in the display panel.

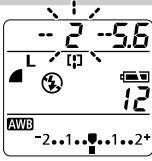

- If the shutter speed is flashing in the display panel or shown in red in the LCD monitor, the image is under- or overexposed (insufficient light). Adjust the aperture value using the ◀ or ▶ arrow on the omni selector until the flashing stops or the shutter speed display turns to white.

- F2.0 and F2.2 cannot be selected when the focal length has been set to the maximum telephoto setting with the zoom lever.



- Please note that camera shake becomes a factor at low shutter speeds. If the camera shake warning  appears in the center of the LCD monitor, secure the camera to a tripod to shoot.
- The following chart shows the relationship between the aperture value and maximum shutter speed.

Aperture Value	Maximum Shutter Speed
F2.0 - 3.2	1/500
F3.5 - 4.5	1/640
F5.0 - 7.1	1/800
F8.0	1/1000

\* When using a flash in this mode, the slowest shutter speed is 1/60 second.

### Aperture Setting Display

The larger the aperture value, the smaller the lens aperture.

F2.0	F2.2	F2.5	F2.8	F3.2	F3.5	F4.0	F4.5	F5.0	F5.6
F6.3	F7.1	F8.0							

The display of aperture settings differs between the display panel and LCD monitor.

Aperture Value	F2.0	· · ·	F8.0
Display Panel	<b>2.0</b>	· · ·	<b>8.0</b>
LCD Monitor	<b>F2.0</b>	· · ·	<b>F8.0</b>

# M Manually Setting the Shutter Speed and Aperture

You can manually set the shutter speed and aperture to achieve a particular effect. This is convenient for shooting fireworks and other images for which it is difficult to set the correct exposure automatically.

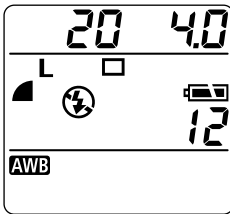
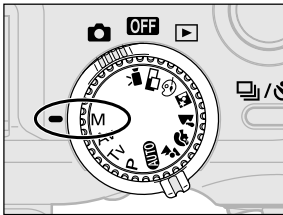

- 1 Turn the mode dial to **M**.
  - The shutter speed and aperture setting will show in the display panel. They will also appear on the LCD monitor if it is on.
- 2 Press the ◀ or ▶ arrow on the omni selector to select a shutter speed.
- 3 Press the ▲ or ▼ arrow on the omni selector to select an aperture setting.
- 4 Shoot the image.
  - When you press the shutter button halfway, the exposure compensation bar displays in the display panel and a number in the LCD monitor indicates the difference between standard exposure\* and the selected exposure. If the difference is more than  $\pm 2$  steps, the LCD monitor and display panel show the following.
    - LCD monitor: a red "-2" or "+2"
    - Display panel: the underscore ■ beneath the value on the exposure compensation bar blinks.

\* The standard exposure is calculated by the AE function according to the selected metering method.



- 
- The exposure compensation, AE Lock, FE Lock, flash exposure compensation, AEB and ISO speed (Auto) settings cannot be adjusted in this mode.



- 
- The 1/1000 second shutter speed can be selected when the aperture is set to F8.0.
  - If you wish to change the exposure, press the ◀ or ▶ arrow on the omni selector to adjust the shutter speed, or the ▲ or ▼ arrow to adjust the aperture.
  - The LCD monitor will not darken if you select a fast shutter speed, set the flash to ⚡👁️ (Red-Eye Reduction Auto) or ⚡ (Flash On) to shoot a subject in a dark place, or attach an external flash, so that you can check the image before shooting.



## Selecting an AF Frame

The AF frame indicates the area of the composition on which the camera focuses. You can select one AF frame from among the three available. This is convenient for focusing accurately on an off-center subject to obtain the composition you desire.

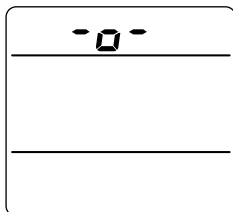

### 1 Press the button.

- The selected AF frame will appear in the display panel. The three AF frames will also appear in the LCD monitor if it is on.

### 2 Press the or arrow on the omni selector to chose an AF frame.

- The selected frame will appear green.

### 3 Press the button.

- You can also press the shutter button directly instead of the  button to shoot with the selected AF frame.

### 4 Shoot the image.



AF Frame



- This function can only be selected in the **P**, **Tv**, **Av** and **M** shooting modes. The center AF frame is used for all other shooting modes. The selected setting is not memorized when the camera power is turned off. Consequently, the center AF frame is selected again the next time the camera is turned on.
- Since the AF frame setting remains in effect while the camera is left on even if the LCD monitor is turned off, it is advisable to keep the LCD monitor on while shooting with this function.
- When the Spot AE Point is selected as the light metering method, you can use the selected AF frame as the Spot AE Point (p. 78).
- For an explanation of the AF frame colors, please refer to page 36.

## Adjusting the Exposure Compensation

Adjust the exposure compensation setting to avoid making the subject too dark when it is backlit or shot against a bright background.

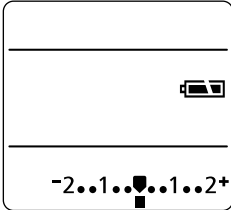

### 1 Press the /WB// button once.

- The exposure compensation bar will appear in the display panel. The bar will also appear in the LCD monitor if it is on.

### 2 Press the ◀ or ▶ arrow on the omni selector to select a setting.

- The settings can be adjusted in 1/3 steps in the range of -2EV to +2EV.

### 3 Press the **SET** button.

- You can also take the picture with the set exposure compensation value by pressing the shutter button directly instead of the **SET** button.
- To cancel the exposure compensation, press the ◀ or ▶ arrow on the omni selector to reset it to ▼.

### 4 Shoot the image.

- If you pressed the shutter button at Step 3, the exposure compensation bar will reappear after the shot, allowing you to change the setting for the next shot.











- This setting cannot be adjusted in the **AUTO** and **M** shooting modes. In  mode, it can only be adjusted for the first image.







- The selected shooting mode will determine whether or not the exposure compensation setting is cancelled when the camera is turned off (p. 85).

# WB Setting the White Balance

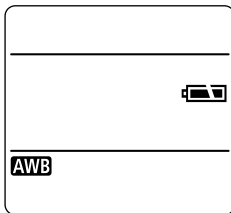
When the white balance mode is set to match the light source, the camera can reproduce colors more accurately. Set the white balance mode to a natural or artificial light setting according to the circumstances.



	<b>Auto</b>	Settings are automatically set by the camera
	<b>Daylight</b>	For recording outdoors on a bright day
	<b>Cloudy</b>	For recording under overcast, shady or twilight skies
	<b>Tungsten</b>	For recording under tungsten and bulb-type 3-wavelength fluorescent lighting
	<b>Fluorescent</b>	For recording under warm-white, cool-white or warm-white (3-wavelength) fluorescent lighting
	<b>Fluorescent H</b>	For recording under daylight fluorescent, or daylight fluorescent-type 3-wavelength fluorescent lighting
	<b>Flash</b>	For flash photography
	<b>Custom</b>	For setting a custom value with a white sheet of paper, etc., to obtain the optimal white balance for the conditions



- 1 Press the /WB// button twice.**
  - The current white balance mode will appear in the display panel. The white balance settings menu will appear in the LCD monitor if it is on.
- 2 Press the ◀ or ▶ arrow on the omni selector to select a setting.**
  - Please see the next page regarding the  custom setting.
- 3 Press the SET button.**
  - You can also take the picture in the set white balance mode by pressing the shutter button directly instead of the SET button.
- 4 Shoot the image.**
  - If you pressed the shutter button at Step 3, the current white balance mode will reappear after the shot, allowing you to change the setting for the next shot.





- This setting cannot be adjusted in the **AUTO** and  (sepia or B/W) shooting modes. In  mode, it can only be adjusted for the first image.



- The selected shooting mode will determine whether or not the white balance setting is cancelled when the camera is turned off (p. 85).

## **Setting a Custom White Balance**

You can set a custom white balance to obtain the optimal setting for the shooting conditions by having the camera evaluate a subject such as a white piece of paper, a white cloth or a photo-quality gray card.

- 1** Press the /WB// button twice.
  - The current white balance mode will appear in the display panel. The WB settings menu will appear in the LCD monitor if it is on.

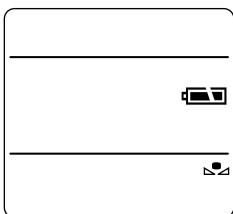

- 2** Press the **◀** or **▶** arrow on the omni selector to select .

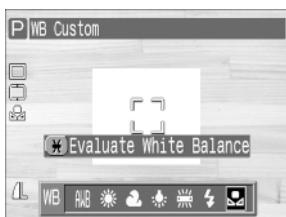



- 3** Aim the camera at the gray card, white paper or cloth and press the **\*** button.
  - Aim the camera so that the white sheet, white cloth or gray card completely fills the frame on the LCD monitor screen or the entire viewfinder before pressing the **\*** button. When you press the **\*** button, the camera reads the white balance data.

- 4** Press the **SET** button.
  - You can also take the picture with the white balance set to the selected value by pressing the shutter button directly instead of the **SET** button.

## 5 Shoot the image.

- If you pressed the shutter button at Step 4, the white balance mode will reappear after the shot, allowing you to change the setting for the next shot.



- To set and use a custom white balance setting, it is advisable to select the **P** shooting mode and set the exposure compensation and flash exposure compensation to zero ( $\pm 0$ ). The correct white balance may not be obtained when the exposure is incorrect (image is completely black or white).
- It is also desirable to use the LCD monitor to compose the shot and to zoom in to the maximum telephoto setting.
- Since the white data cannot be read in the  mode, pre-set the white balance in another shooting mode first before selecting the  mode.
- If the flash fires when setting a custom white balance with the flash set to auto or red-eye reduction auto, use the flash when you go to shoot too. The correct white balance cannot be obtained unless the flash is used consistently. To ensure consistency, set the flash to on or off as appropriate.
- The selected custom white balance setting will be memorized even when the camera's power is turned off.

## Auto Exposure Bracketing (AEB Mode)

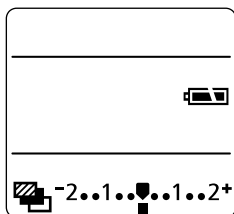

In this mode, the camera automatically changes the exposure within a set range to take three shots after you press the shutter button once. You can adjust AEB settings in 1/3EV steps within the range of -2EV to +2EV of the standard exposure setting. AEB settings can be combined with exposure compensation settings (p. 69) to extend the adjustment range. The images are shot in the following order: Standard exposure, underexposure and overexposure.



### 1 Press the /WB// button three times.

- The  icon and the exposure compensation bar will appear in the display panel. The exposure compensation bar will also appear in the LCD monitor if it is on.

### 2 Press the or arrow on the omni selector to expand or contract the range.

- The  arrow expands the range, the  arrow contracts it.

### 3 Press the **SET** button.

- You can also take the picture with the set exposure compensation value by pressing the shutter button without pressing the **SET** button.
- To cancel the AEB setting, reset it to .

### 4 Shoot the image.

- If you pressed the shutter button at Step 3, the  icon and the exposure compensation bar will reappear after the shot, allowing you to change the setting for the next shot.



- The AEB mode cannot be used for flash photography. If the flash fires, only one image gets recorded.





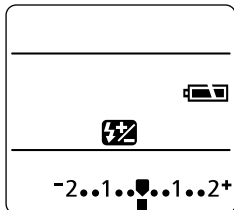

- This function can only be selected in the **P**, **Tv** and **Av** shooting modes.
- The selected AEB setting will be memorized even when the camera's power is turned off.

## Adjusting the Flash Output (Flash Exposure Compensation)

You can adjust the flash output for flash photography.



- 1** Press the /WB// button four times.
  - The  icon and the flash exposure compensation bar will appear in the display panel. The flash exposure compensation bar will also appear in the LCD monitor if it is on.
- 2** Press the ◀ or ▶ arrow on the omni selector to expand or contract the range.
  - The flash exposure compensation can be adjusted in 1/3 steps within a range of -2EV to +2EV.
- 3** Press the **SET** button.
  - You can also take the picture with the set flash exposure compensation value by pressing the shutter button directly instead of the **SET** button.
  - To cancel the setting, press the ◀ or ▶ arrow on the omni selector to reset it to ▼.
- 4** Shoot the image.
  - If you pressed the shutter button at Step 3, the  icon and the flash exposure compensation bar will reappear after the shot, allowing you to change the setting for the next shot.



- This setting cannot be adjusted in the **AUTO**,  and **M** shooting modes. In  mode, it can only be adjusted for the first image.



- The selected shooting mode will determine whether or not the flash exposure compensation setting is memorized even when the camera power is turned off (p. 85).
- The flash exposure compensation mode only functions with the built-in flash or an externally mounted EX series Speedlite or a Macro Ring Lite (p. 123).
- In the **M** shooting mode, the built-in flash will only fire at full intensity, but you can adjust the output of an EX series Speedlite or the Macro Ring Lite.

## \* Locking the Exposure Setting (AE Lock)

You can set the exposure and focus separately. This is effective when the contrast is too strong between the subject and background or when a subject is backlit. For an explanation of how different combinations of light metering options and a selected AF frame affect where the AE lock is metered, see page 76.

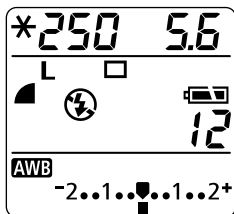

- 1 Press the **DISPLAY** button to turn on the LCD monitor.
- 2 Focus on the subject on which you wish to lock the exposure setting.
  - Press the shutter button halfway.
- 3 Press the \* button.
  - The exposure setting will lock (AE Lock) and the \* icon will appear in the display panel and LCD monitor.
  - Pressing any button other than the shutter button or omni selector cancels the AE lock.



AE Lock Icon



- 4 Recompose the image and shoot.



- The AE lock function cannot be used when the optical viewfinder is used to shoot.



- This function can only be selected in the **P**, **Tv** and **Av** shooting modes.



- The automatically selected combinations of shutter speeds and aperture values can be freely changed without altering the exposure with the following procedures.
  - 1 Turn the mode dial to **P**, **Tv** or **Av**.
  - 2 Press the **DISPLAY** button to turn on the LCD monitor.
  - 3 Focus on the subject on which you wish to lock the exposure.
  - 4 Press the **\***  button.
    - The exposure setting will lock and the **\***  icon will appear in the display panel and LCD monitor.
  - 5 Press the **◀** or **▶** arrows on the omni selector until the desired shutter speed or aperture value is reached.
  - 6 Recompose the image and shoot.  
The setting will cancel after the shot is taken.

### Exposure Metering Position for the AE/FE Lock According to Different Light Metering Options when an AF Frame is Selected (Creative Shooting Modes)

Light Metering Option	AF Frame Is Selected	
Evaluative Metering	AE/FE locks at the exposure metered within the selected AF frame	
Center-Weighted Averaging	AE/FE locks at the exposure metered in the center AF frame	
Spot AE Point	Center	AE/FE locks at the exposure metered in the spot AE point at the center
	AF Point	AE/FE locks at the exposure metered in the spot AE point corresponding to the selected AF frame

## \* Locking the Flash Exposure Setting (FE Lock)

You can lock the flash exposure so that the exposure settings are correctly set for a particular portion of your subject. For an explanation of how different combinations of light metering options and a selected AF frame affect where the FE lock is metered, see page 76.

- 1** Press the **DISPLAY** button to turn on the LCD monitor.
- 2** Set the built-in flash to fire.
  - If you are using an externally mounted flash, please refer to its manual for setting instructions.
- 3** Focus on the subject on which you wish to lock the flash exposure setting.
  - Press the shutter button halfway.

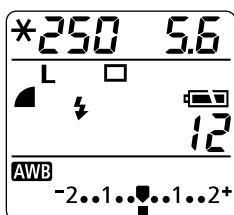

- 4** Press the \* button.
  - The flash exposure compensation setting will lock (FE lock) and the \* icon will appear in the LCD monitor and display panel.
  - The flash will fire a pre-flash and lock the flash exposure to the required intensity to illuminate the subject. (Each time you press the \* button, the flash exposure locks at the required intensity for that composition).
  - Pressing any button other than the shutter button or omni selector cancels the FE lock.



- 5** Recompose the image and shoot.
  - As the example to the left shows, a backlit subject can be shot at the correct exposure if the FE lock is set when the camera is aimed at a non-backlit portion of the subject.





- This function can only be selected in the **P**, **Tv** and **Av** shooting modes.
- The FE lock only functions with the built-in flash, an externally mounted EX series Speedlite or a Macro Ring Lite (p. 123).







## Switching between Metering Modes

You can switch between metering modes to shoot. Evaluative metering is the default mode.

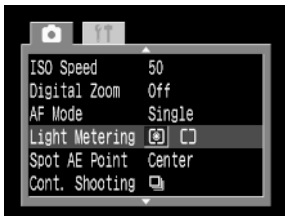
Metering Mode	 Evaluative Metering	Appropriate for standard shooting conditions, including backlit scenes. The camera divides images into several zones for metering. The camera evaluates the complex lighting conditions, such as the position of the subject, the brightness, the direct light, and the backlighting, and adjusts the settings to the correct exposure for the main subject.
	 Center-Weighted Averaging	Averages the exposure from the entire image, but places more weight on the subject at the center. Use this mode when the subject is backlit or surrounded by bright light.
Spot AE Point	Center	Meters the area within the spot AE point frame at the center of the LCD monitor.
	AF Point	Meters the spot AF point corresponding to the selected AF frame.

## Selecting a Light Metering Option



- 1 Turn the mode dial to **P**, **Tv** or **Av**.
- 2 In the [ (Rec.)] menu, select [Light Metering].
  - See Selecting Menus and Settings (p. 39).
- 3 Select the [ (Evaluative Metering)] or [ (Center-Weighted Averaging)] option.
  - The symbol of the selected option will appear in the LCD monitor.
- 4 Press the **MENU** button.



## Selecting a Spot AE Point Option

---

- 1 Turn the mode dial to **P**, **Tv** or **Av**.
- 2 In the [📷 (Rec.)] menu, select [Spot AE Point].
  - See Selecting Menus and Settings (p. 39).
- 3 Select the [Center] or [AF Point] option.
- 4 Press the **MENU** button.
  - The spot AE point setting will take effect. Press the [📷] button and shoot the image.

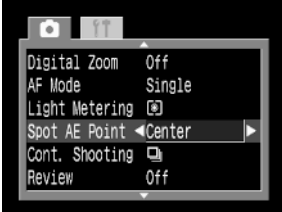

## Switching to Spot AE Point Metering

---

- 1 Turn the mode dial to **P**, **Tv** or **Av**.
- 2 Press the [📷] button.
  - With each push of the [📷] button, metering switches between the light metering and spot AE point methods.
  - When a spot AE point is selected, the [📷] symbol will appear in the display panel. When the center option is selected, the spot AE point frame appears at the center of the LCD monitor, and when the AF point option is selected it appears on the inside of the selected AF frame.
- 3 Shoot the image.



- This function can only be selected in the **P**, **Tv** and **Av** shooting modes.
- The setting is cancelled when the camera power is turned off. However, the option selected in the menu remains selected.
- Since the display panel shows the same symbol for the light metering options, you can look at the LCD monitor to tell which option is currently selected.

# Shooting Problem Subjects for the Autofocus

The autofocus may not work well on the following types of subject.

- Subjects with extremely low contrast to the surroundings
- Subjects mixing close and far objects
- Subjects with extremely bright objects at the center of the composition
- Subjects that are moving quickly

To shoot these subjects, first aim the camera at an object at a similar distance, lock the focus and recompose the image with the desired subject, or use the manual focus.



- When shooting through glass, approach as close as possible to avoid reflections off the glass.

## Shooting with Focus Lock

### Focus Lock Method 1

- 1** Aim the center of the viewfinder (or the selected AF frame in the LCD monitor if it is on) at an object at a similar distance to the subject you wish to shoot.
- 2** Press the shutter button halfway to lock the focus.
  - The AE setting will also lock when you do this. The exposure may occasionally be incorrect if the difference between the target subject and the subject of the focus lock is too great. In that case, shoot with Method 2 below or use the AE lock to shoot.
- 3** Keep it pressed while you recompose and press the shutter button all the way to shoot the image.

### Focus Lock Method 2

- 1** Press the **DISPLAY** button to turn on the LCD monitor.
- 2** Aim the center of the LCD monitor (or the selected AF frame) at an object at a similar distance to the subject you wish to shoot.
- 3** Press the shutter button halfway to lock the focus. Keep it pressed and press the **MF** button.
  - The **MF** icon will appear in the display panel and the **MF** icon in the LCD monitor.
  - The focus setting will lock even if the shutter button and MF button are released.
  - Pressing the MF button a second time cancels the focus lock.

## 4 Recompose the image and press the shutter button all the way to shoot the image.



- Method 2 is convenient because you can let go of the shutter button to recompose the image.

## Shooting in Manual Focus Mode

The focus can be manually set.

**1** Press the **DISPLAY** button to turn the LCD monitor on.

**2** Press and hold the MF button and press the **▲** or **▼** arrow on the omni selector.



MF indicator

- The focus will lock and the **MF** icon will show in the display panel. The **MF** icon and MF indicator will appear in the LCD monitor. If an AF frame has been selected, the portion of the image in that frame will appear magnified\*.

\* Except in the and modes, when the digital zoom is activated, or a TV is used as the display.

- The MF indicator shows approximate figures. Use them as a shooting guideline only.
- Adjust the focus with the **▲** or **▼** arrow on the omni selector until the image appears focused in the LCD monitor.
- Pressing the MF button a second time cancels the manual focus mode.

**3** Shoot the image.



- This setting cannot be adjusted in the **AUTO** and shooting mode.



- You can use manual focus in the macro focal range (6 to 70 cm (2.4 in. to 2.3 ft.) at maximum wide angle and 20 to 70 cm (7.9 in. to 2.3 ft.) at maximum telephoto).
- The MF indicator units become finer in the macro focal range.

# Switching between Focus Settings

You can switch between focus settings to shoot.

<b>Continuous</b>	The camera is continually focusing on whatever it is aimed even when the shutter button is not pressed, allowing you to shoot without missing opportunities.
<b>Single</b>	The camera only focuses when the shutter button is pressed halfway, conserving battery power.

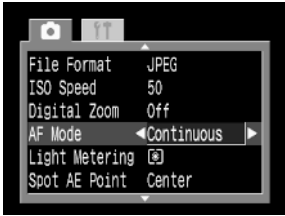

- 1 In the [📷 (Rec.)] menu, select [AF Mode].
  - See Selecting Menus and Settings (p. 39).
- 2 Select [Continuous] or [Single] and press the **MENU** button.
- 3 Shoot the image.



- These settings cannot be adjusted in the 📷 shooting mode.
- When the LCD monitor is off, the setting locks in the Single mode.



- The setting is memorized even when the camera power is turned off.

# Manually Setting Image Characteristics

The ISO speed, contrast, sharpness and saturation settings can be adjusted for shooting.

**1** In the [📷 (Rec.)] menu, select one of the above items.

- See Selecting Menus and Settings (p. 39).

**2** Select a value for the item and press the **MENU** button.

## ISO speed

- Switch speeds when you are shooting in dark areas or want to use a fast shutter speed.
- You can select from 50, 100, 200, 400 and AUTO.
- The default setting is ISO 50.
- Higher ISO speeds increase the image noise. To take clean images, use as low an ISO speed as possible.

## Contrast

- Select from - (Weak), 0 (Neutral) and + (Strong).
- This function allows you to adjust the degree of brightness.

## Sharpness

- Select from - (Weak), 0 (Neutral) and + (Strong).
- This function allows you to adjust how sharply outlines are defined.

## Saturation

- Select from - (Low), 0 (Neutral) and + (High)
- This function allows you to adjust the color depth.

**3** Shoot the image.

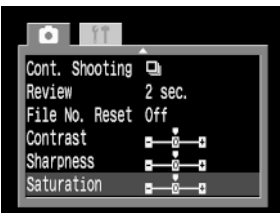
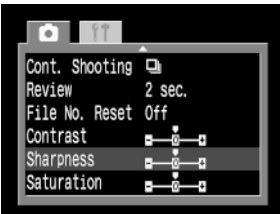
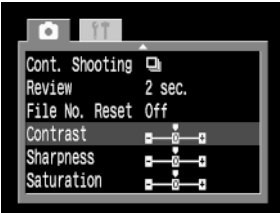
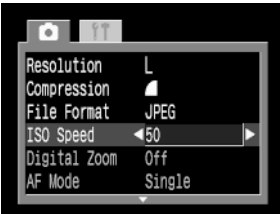

- These functions can only be selected in the **P**, **Tv**, **Av** and **M** shooting modes. In the **M** mode, however, the ISO speed cannot be set to [Auto].
- These settings are memorized even when the camera power is turned off.

# Resetting the File Number

You can select the way file numbers are assigned.

<b>On</b>	File number is reset to the start (100-0001) each time a new CF card is inserted. New images recorded on CF cards with existing files are assigned the next available number.
<b>Off</b>	The file number of the last image to be shot is memorized so that images recorded to a new CF card start from the next number.

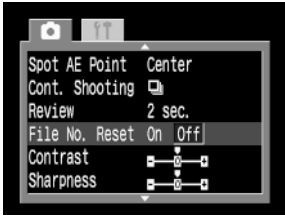

**1** In the [ (Rec.)] menu, select [File No. Reset].

- See Selecting Menus and Settings (p. 39).

**2** Select [On] or [Off] and press the **MENU** button.



- Setting the [File No. Reset] to [Off] is useful for avoiding file name duplication when images are downloaded to a computer.



## About File Numbers

- Images are assigned file numbers from 0001 to 9900 and organized in folders usually containing up to 100 images. Folders are assigned numbers from 100 to 998.

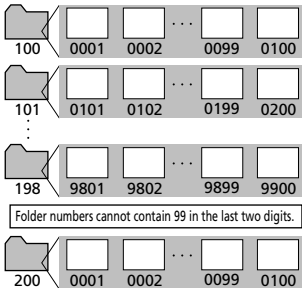

Since images shot in continuous mode or Stitch Assist mode are always saved in the same folder, some folders may contain 101 or more images.

# Functions Available in Each Shooting Mode

This chart shows the functions available in each shooting mode.

																							Reference Page		
Flash	Auto	●	●*	●	●	●	—	—	●	—	—	—	—	—	—	—	—	—	—	—	—	—	p. 43		
	Red-Eye Reduction, Auto	●*	●	●*	●	●*	—	—	●	—	—	—	—	—	—	—	—	—	—	—	—	—		p. 43	
	Red-Eye Reduction, Flash On	—	●	●	●	●	—	—	●	●	●	●	●	●	—	—	—	—	—	—	—	—			p. 43
	On	—	●	●	●	●	▲	—	●	●	●	●	●	●	—	—	—	—	—	—	—	—			
	Off	●	●	●	●*	●	▲*	●*	●*	●*	●*	●*	●*	●*	—	—	—	—	—	—	—	—			—
Macro Mode		●	—	●	—	—	●	●	●	●	●	●	●	●	●	●	●	●	●	●	●	●	p. 53		
Drive Mode	Single Shot	●*	●*	●*	●*	●*	●*	●*	●*	●*	●*	●*	●*	●*	●*	●*	●*	●*	●*	●*	●*	●*	—		
	Continuous	—	●	●	●	●	—	—	●	●	●	●	●	●	—	—	—	—	—	—	—	—	p. 55		
	Self-Timer	●	●	●	●	●	●	●	●	●	●	●	●	●	—	—	—	—	—	—	—	—	p. 54		
AF Frame		— <sup>(1)</sup>	— <sup>(1)</sup>	— <sup>(1)</sup>	— <sup>(1)</sup>	— <sup>(1)</sup>	— <sup>(1)</sup>	— <sup>(1)</sup>	●	●	●	●	●	●	—	—	—	—	—	—	—	—	p. 68		
Exposure Compensation		—	●	●	●	●	▲	●	●	●	●	●	●	●	—	—	—	—	—	—	—	—	p. 69		
White Balance		—	●	●	●	●	● <sup>(2)</sup>	▲	●	●	●	●	●	●	—	—	—	—	—	—	—	—	p. 70		
AEB Mode		—	—	—	—	—	—	—	●	●	●	●	●	—	—	—	—	—	—	—	—	—	p. 73		
Flash Exposure Compensation		—	●	●	●	●	▲	—	●	●	●	●	●	— <sup>(3)</sup>	—	—	—	—	—	—	—	—	p. 74		
AE Lock / FE Lock		—	—	—	—	—	—	—	●	●	●	●	●	—	—	—	—	—	—	—	—	—	p. 75, 77		
Spot AE Point		—	—	—	—	—	—	—	●	●	●	●	●	—	—	—	—	—	—	—	—	—	p. 78		
Light Metering		—	—	—	—	—	—	—	●	●	●	●	●	—	—	—	—	—	—	—	—	—	p. 78		
Spot AE Point Frame		—	—	—	—	—	—	—	●	●	●	●	●	—	—	—	—	—	—	—	—	—	p. 79		
Manual Focus		—	—	●	●	●	●	●	●	●	●	●	●	●	●	●	●	●	●	●	●	●	p. 81		
Resolution	Large	●*	●*	●*	●*	●*	▲*	—	●*	●*	●*	●*	●*	—	—	—	—	—	—	—	—	—	p. 58		
	Medium 1	●	●	●	●	●	▲	—	●	●	●	●	●	—	—	—	—	—	—	—	—	—			
	Medium 2	●	●	●	●	●	▲	—	●	●	●	●	●	—	—	—	—	—	—	—	—	—			
	Small	●	●	●	●	●	▲	—	●	●	●	●	●	—	—	—	—	—	—	—	—	—			
	Movie (320/160)	—	—	—	—	—	—	—	●	—	—	—	—	—	—	—	—	—	—	—	—	—			
Compression	Superfine	●	●	●	●	●	—	—	●	●	●	●	●	—	—	—	—	—	—	—	—	—			
	Fine	●*	●*	●*	●*	●*	●*	—	●*	●*	●*	●*	●*	—	—	—	—	—	—	—	—	—	p. 58		
	Normal	●	●	●	●	●	—	—	●	●	●	●	●	—	—	—	—	—	—	—	—	—			
File Format	JPEG	●	●	●	●	●	●	—	●*	●*	●*	●*	●*	—	—	—	—	—	—	—	—	—	p. 60		
	RAW	—	—	—	—	—	—	—	●	●	●	●	●	—	—	—	—	—	—	—	—	—			
ISO Speed		— <sup>(4)</sup>	— <sup>(4)</sup>	— <sup>(4)</sup>	— <sup>(4)</sup>	— <sup>(4)</sup>	— <sup>(4)</sup>	— <sup>(4)</sup>	— <sup>(3)</sup>	●	●	●	●	●	●	●	●	●	●	●	●	● <sup>(5)</sup>	p. 83		
Digital Zoom Function		●	—	●	●	●	—	—	●	●	●	●	●	—	—	—	—	—	—	—	—	—	p. 57		
Focus Settings	Continuous	●*	—	●*	●*	●*	●*	●	●*	●*	●*	●*	●*	—	—	—	—	—	—	—	—	—	p. 82		
	Single	●	—	●	●	●	●	—	●	●	●	●	●	—	—	—	—	—	—	—	—	—			
Contrast, Sharpness, Saturation		—	—	—	—	—	—	—	●	●	●	●	●	—	—	—	—	—	—	—	—	—	p. 83		

\* Default setting.

▲ Setting can only be selected for the first image.

■ (Shaded Area) Setting is memorized even when the camera power is turned off.

(1) AF frame is fixed at the center position.

(3) Please refer to page 74.

(5) [Auto] cannot be selected.

● Setting selection is possible.

— Setting selection is not possible.

■ (Shaded Area) Setting is memorized even when the camera power is turned off.

(2) The [sepia] and [B/W] options cannot be selected.

(4) ISO 50-100 equivalents are set automatically.

# Replaying

## Viewing Images Singly (Single Image Replay)

You can view the recorded images in the LCD monitor.



- 1** Open the LCD monitor.
  - The LCD monitor can be freely opened to any position (p. 31).

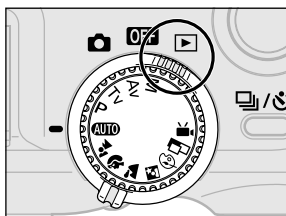

- 2** Turn the main dial to .
- The last recorded image will display (Single Image Replay).



- 3** Press the ◀ or ▶ arrow on the omni selector to move between images.
  - The ◀ arrow moves to the previous image and the ▶ arrow to the next. Holding the button down moves more rapidly between images, but the images will not appear as clearly.



- Press the **DISPLAY** button to show the data for the displayed image (p. 34).
- Press the  button to delete the displayed image (p. 9).
- You can change the language displayed on the LCD monitor if you hold the **SET** button and press the **JUMP** button (p. 27). (This shortcut cannot be accessed, however, when Card Photo Printer CP-10 (optional) is connected.)



## Magnifying Images

In single image replay, the displayed image can be magnified by an approximate factor of 3 or 6.





**1** Turn the main dial to .



Magnified approximately 3 times

Approximate position

**2** Move the zoom lever toward the  symbol.

- The display cycles to the next magnification level (approximately 3 and then 6 times) each time the zoom lever is moved toward the  symbol.
- Press the , ,  or  arrows on the omni selector to move the magnified area around the image.



Magnified approximately 6 times

Approximate position

**3** Move the zoom lever toward the  symbol.

- When the magnification is set to approximately 6 times, it returns to the 3-times setting with the first shift of the lever and back to standard single image replay mode with the second.



• The magnification function does not work for movies or in the index replay mode.



• You can magnify an image while it is displayed in the LCD monitor in shooting mode immediately after it is shot.

# Viewing Nine Images at a Time (Index Replay)

Up to nine images can be viewed at once in Index Replay.

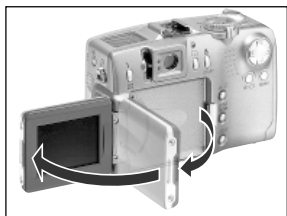

- 1** Open the LCD monitor.
  - The LCD monitor can be freely opened to any position (p. 31).





- 2** Turn the main dial to .





Movie Frame

Selected Image

- 3** Press the  button.
  - Nine images will display at once (Index Replay).

- 4** Press the , ,  or  arrows on the omni selector to change the image selection.



- ← • Pressing the  arrow in this row displays the previous set of nine images.
- ← • Pressing the  arrow in this row displays the next set of nine images.

- 5** Press the  button.
  - Index replay cancels and the display reverts to single image replay.



- Press the **DISPLAY** button to show the data for the displayed image (p. 34).

# JUMP Jumping between Images

The display can be advanced or set back 9 images in either single image replay or index replay.

- 1 Turn the main dial to  and select either single image replay or index replay.
- 2 Press the **JUMP** button.
  - The jump bar will display.
- 3 The displayed image(s) will change.



Jump Bar



Jump Bar

## Single Replay

- Press the ◀ or ▶ arrow on the omni selector to jump 9 images behind or ahead.
- Hold the **SET** button and press the ◀ or ▶ arrow on the omni selector to jump to the first or last image.

## Index Replay

- Press the ◀ or ▶ arrow on the omni selector to jump to the previous or next set of nine images.
- Hold the **SET** button and press the ◀ or ▶ arrow on the omni selector to jump to the first or last set of nine images.

- 4 Press the **JUMP** button.
  - The jump bar will cease displaying and the jump mode will cancel.

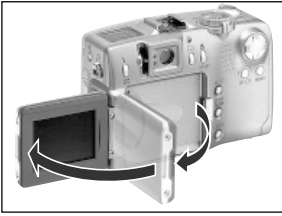

# Viewing Movies

You can replay the images shot in **MOVIE** mode.



- 1 Open the LCD monitor.**
  - The LCD monitor can be freely opened to any position (p. 31).

- 2 Turn the main dial to .**
  - Movies cannot be viewed in index replay.

- 3 Press the  or  arrow on the omni selector to display an image shot in **MOVIE** mode.**



- 4 Press the **SET** button.**
  - The movie images and sound will play.
  - When a movie has finished playing, it will stop and display the last frame. If the **SET** button is pressed in this state, the movie will start playing from the first frame.



## Pausing and Resuming Play

- Press the **SET** button to pause the movie. Press it again to resume.

## Next / Previous

- Press the  or  arrow on the omni selector to stop the movie and display the previous or next image or movie.



- You may experience frame dropping and audio breakup when replaying a movie on a computer with insufficient system resources.



- The volume at which movies replay can be adjusted in the Play menu (p. 118).
- Please adjust the audio sound level on the TV when viewing movie files on a TV.

# Rotating Images in the Display

Images can be rotated 90° and 270° clockwise in the LCD monitor.

Original



90°



270°

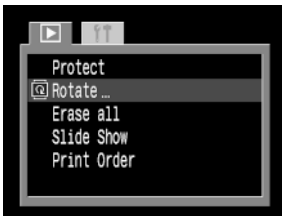

## 1 In the [▶] (Play) menu, select [Rotate] and press the **SET** button.

- See Selecting Menus and Settings (p. 39).



## 2 Press the ◀ or ▶ arrow on the omni selector to select an image you want to rotate and press the **SET** button.

- The image cycles to the next orientation (90° → 270° → original) each time the **SET** button is pressed.

## 3 Press the **MENU** button.

- The Play menu will display again. Press the **MENU** button again to close the menu.



- Movie images cannot be rotated.



- When images are downloaded to a computer, the orientation of images rotated by the camera will depend upon the software used to download the images.
- Images can be magnified when rotated (p. 87).

# Automated Playback (Slide Show)

## Starting a Slide Show

All images, or a selection of images, can be displayed one-by-one in an automated slide show.

<b>All Images</b>	Plays all the images on the CF card in order
<b>Slide Show 1 - 3</b>	Plays the images selected for each show in order

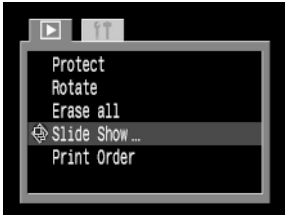

**1** In the [ (Play)] menu, select [Slide Show] and press the **SET** button.

- See Selecting Menus and Settings (p. 39).
- The slide show menu will display.



**2** Press the ▲ or ▼ arrow on the omni selector to select [Program]. Press the ◀ or ▶ arrow to select between [All Images] or any one of slide [Show 1]-[Show 3].

**3** Press the ▲ or ▼ arrow on the omni selector to select [Start] and press the **SET** button.

- The slide show will start and automatically stop when the show is done.

### Pausing and Resuming a Slide Show

- Press the **SET** button to pause the show. Press it again to resume.

### Fast Forward / Rewinding a Slide Show

- Press the ◀ or ▶ arrow on the omni selector to move on to the previous or next image.

### Stopping a Slide Show

- Press the **MENU** button during a slide show to stop it and display the slide show menu.

## 4 Press the **MENU** button.

- The Slide Show menu will display again. Press the **MENU** button again to close the menu.



- Movie images play for the length of time that they were recorded regardless of the time set in the slide show settings.
- The power save function is disabled while a slide show plays on the camera (p. 30).

## Selecting Images for Slide Shows

You can mark images for inclusion in slide shows 1-3. Up to 100 images may be marked per slide show. Images display in the order of their selection.

**1** Display the slide show menu.



**2** Press the ▲ arrow on the omni selector to select [Program]. Press the ◀ or ▶ arrow to select [Show 1], [Show 2] or [Show 3].

- A bright green bar will appear beside a show already containing images.

**3** Press the ▼, ◀ or ▶ arrow on the omni selector to choose [Select] and press the SET button.

**4** Mark images to include in the show.  
**Single Replay**

- Move between images with the ◀ or ▶ arrow on the omni selector and mark or remove marks from images with the ▲ and ▼ arrow.
- The selection number and a bright green bar will show at the top of marked images.

### Index Replay

- Press the  button to switch to index replay (3 images).
- Press the ◀ or ▶ arrow on the omni selector to select an image and mark or remove marks from images with the ▲ and ▼ arrow.
- The selection number and a bright green bar will show at the bottom of marked images.
- You can deselect all the images in a show by pressing the SET button, selecting [OK] with the ◀ or ▶ arrow and pressing the SET button again.

**5** Press the MENU button.

- The image selection screen will close.





# Adjusting the Play Time and Repeat Settings

You can change the play time for all the images in a show and have the show repeat itself continuously.

<b>Play Time</b>	Sets the duration that each image in a slide show is displayed. The options are any one of 3-10 seconds, 15 seconds, 30 seconds and Manual.
<b>Repeat</b>	Sets whether the slide show stops when all the slides have been displayed or continues to display until stopped.

- 1 Display the slide show menu.
- 2 Press the ◀ or ▶ arrow on the omni selector to select [Set up] and press the SET button.
- 3 Press the ▲ or ▼ arrow on the omni selector to select [Play Time] or [Repeat].
- 4 Press the ◀ or ▶ arrow on the omni selector to select a setting.

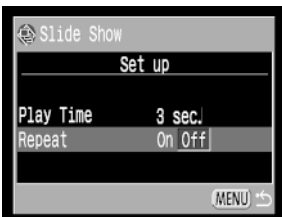
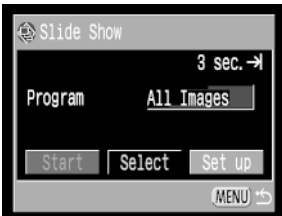

### Play Time

- Select a play time with the ◀ or ▶ arrow on the omni selector.

### Repeat

- Select [On] or [Off] with the ◀ or ▶ arrow on the omni selector.

- 5 Press the MENU button.
  - The set up menu will close.



- The display interval may vary somewhat for some images.
- Slide shows can be easily edited on a computer with the bundled software.

# Protecting Images

You can protect important images from accidental erasure.

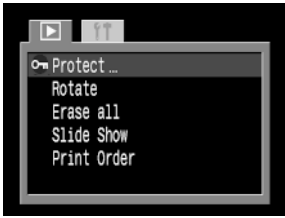

**1** In the [ (Play)] menu, select [Protect] and press the **SET** button.

- See Selecting Menus and Settings (p. 39).



**2** Press the ◀ or ▶ arrow on the omni selector to move to and select an image you want to protect and press the **SET** button.

- The icon will appear on protected images.
- To remove the protection, click the **SET** button again (in protection mode).
- You can make image selection easier by toggling between single replay and index replay with the button.

**3** Press the **MENU** button.

- The protect window will close.



- Please note that formatting (initializing) a CF card (p. 99) erases all its data, including protected images and other types of data. Please check the contents of a CF card before formatting it.

# Erasing

## Erasing Images Singly



- Please note that erased images cannot be recovered. Exercise adequate caution before erasing a file.

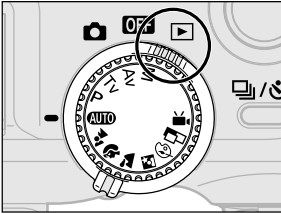

**1** Turn the main dial to [▶].

**2** Press the ◀ or ▶ arrow on the omni selector to select the image you wish to erase and press the button.



**3** Press the ◀ or ▶ arrow on the omni selector to select [Erase] and press the **SET** button

- To cancel instead of erasing, select [Cancel] and press the **SET** button.





- Protected images cannot be erased with the erase function (p. 96).

# Erasing All Images

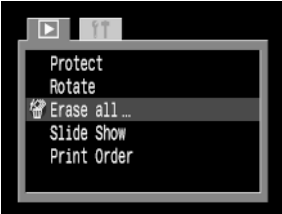

- Please note that erased images cannot be recovered. Exercise adequate caution before erasing a file.



**1** In the [ (Play)] menu, select [Erase all] and press the **SET** button.

- See Selecting Menus and Settings (p. 35)



**2** Press the ◀ or ▶ arrow on the omni selector to select [OK] and press the **SET** button.

- To cancel instead of erasing, select [Cancel] and press the **SET** button.



- Protected images cannot be erased with the erase function (p. 96).

# Formatting a CF Card

You should format a new CF card or one from which you wish to erase all images and other data.

Formatting may restore a CF card if it returns an error or if the “CF” message displays.



- Please note that formatting (initializing) a CF card erases all data, including protected images (p. 96) and other file types. Please check the contents of a CF card before formatting it.



**1** In the [**Fn**] (Set up) menu, select [Format] and press the **SET** button.

- See Selecting Menus and Settings (p. 39)



**2** Press the ◀ or ▶ arrow on the omni selector to select [OK] and press the **SET** button.

- To cancel formatting instead, select [Cancel] and press the **SET** button.



- When a non-Canon brand CF card is malfunctioning, reformatting it may solve the problem.
- CF cards formatted in another camera, computer or peripheral device may not operate correctly. When that happens, reformat the CF card with this camera.

# Print Settings (DPOF Settings)

Images on a CF card can be individually selected for printing in a specified number of copies. You can also select the print type and whether or not to print the date and file number. These settings are compatible with the Digital Print Order Format (DPOF) standards so that images can be printed on DPOF-compliant digital printers or at participating photo labs.



- The  mark will display on images that have had print marks set by another DPOF-compliant camera. These settings will be overwritten by any set by your camera.
- Print settings cannot be set for movie images or RAW images.
- The output of some digital printers or photo lab services may not reflect the specified print settings.



- After you have set the DPOF settings, you can connect Card Photo Printer CP-10 (optional) and print directly from the camera (p. 112).

## Selecting Images for Printing

There are two ways to select images.

- Singly
- All images on a CF card (the number of copies is set to one per image)



**1** In the [ (Play)] menu, select [Print Order] and press the **SET** button.

- See Selecting Menus and Settings (p. 39).
- The Print Order menu will display.



**2** Press the **◀** or **▶** arrow on the omni selector to select [Order] and press the **SET** button.

## 3 Select images for printing.



### Single Images

- When the print type (p. 102) is set to [Standard] or [Both], press the ◀ or ▶ arrow on the omni selector to select an image and the ▲ or ▼ arrow to mark it for printing. You can set the number of copies (up to 99) to be printed at the same time.
- When the print type (p. 102) is set to [Index], press the ◀ or ▶ arrow on the omni selector to select an image and mark or remove marks from images with the ▲ or ▼ arrow.
- You can use the same procedures to select images in index replay (3 images). Press the  button to switch between single replay and index replay.

### All the Images on a CF Card

- Press the  button to switch to index replay (3 images).
- You can set one copy of each image to print by pressing the **SET** button, pressing the ▲ or ▼ arrow on the omni selector to select [Mark all], and pressing the **SET** button again.
- When the print type is set to [Standard] or [Both], the setting for the number of print copies can be changed for each image. When [Index] is selected, the print settings can be deleted. For the instructions for changing settings, please reread Step 3 from the beginning.
- You can cancel all the settings by selecting [Clear all].

## 4 Press the MENU button.

- The selection mode will turn off and the Print Order menu will reappear.



- 
- Images are printed in order from oldest to newest by the shooting date.
  - A maximum of 998 images can be marked per CF card.
  - When [Both] is selected, the number of copies can be set, but applies to standard prints only. Only one copy can be set to print with the [Index] setting.
  - Print settings can also be assigned to images with the bundled software programs on a computer.



# Setting the Print Style

The following print settings can be selected.

<b>Print Type</b>	Standard	Prints one image per page
	Index	Prints the selected images together at a reduced size in an index format
	Both	Prints the images in both the standard and index formats
<b>Date</b>		Adds the date to the print
<b>File No.</b>		Adds the file number to the print

- 1 Display the Print Order menu.
- 2 Press the ◀ or ▶ arrow on the omni selector to select [Set up] and press the SET button.
- 3 Press the ▲ or ▼ arrow on the omni selector to select [Print Type], [Date] or [File No.]
- 4 Press the ◀ or ▶ arrow on the omni selector to select a setting.

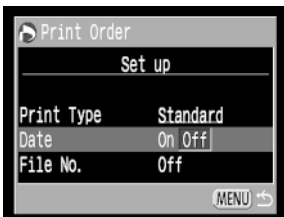
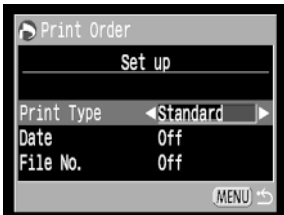
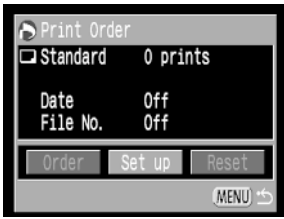

## Print Type

- Select [Standard], [Index] or [Both].

## Date

- Select [On] or [Off].

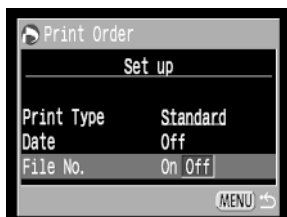

### File No.

- Select [On or [Off].

## 5 Press the **MENU** button.

- The set up menu will close.



- 
- The [Date] and [File No.] options cannot both be set to [On] when the print type is set to [Index].
  - When the print type is set to the [Both] option, it is possible to have both the date and file number selected by the camera, but only the file number will print on the index images.



- 
- The date prints as the date and time in the format specified in the Set Date/Time menu (p. 26).

# Resetting the Print Settings

The print settings can all be removed at once. The print type is reset to [Standard] and the date and file number options are set to [Off].

---

**1** Display the Print Order menu.

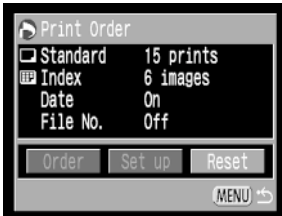

**2** Press the ◀ or ▶ arrow on the omni selector to select [Reset] and press the SET button.

**3** Press the ◀ or ▶ arrow on the omni selector to select [OK] and press the SET button.



# Printing with Card Photo Printer CP-10 (Optional)

Card Photo Printer CP-10, sold separately, can be connected to the camera and used to print images very easily directly from the camera. It can also be used with the DPOF print settings.

## Connecting Card Photo Printer CP-10 to the Camera

Two direct interface cables are supplied with the printer. Use the cable (DIF-200) that has a ► Symbol on the connector to connect to this camera.



- You are recommended to use a household power supply to power the camera when it is connected to the printer. If you are using a battery pack, ensure that it is fully charged and monitor the battery charge while printing.

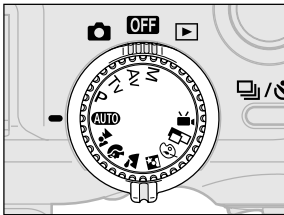

**1** Turn the camera's power off.

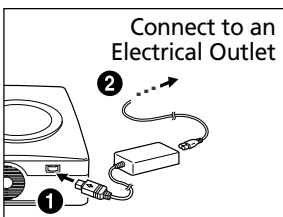

**2** Attach the power cable to the printer and plug the other end into the electrical outlet.

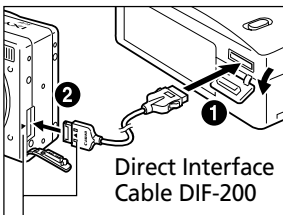

**3** Attach the direct interface cable to the printer.

**4** Open the camera's terminal cover and plug the direct interface cable into the digital terminal.

Align the ► symbol on the camera and cable.

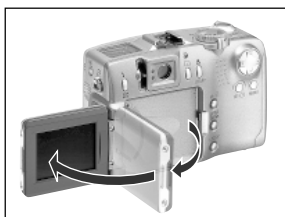

**5** Open the LCD monitor.

Conncted to the Printer





**6** After the printer is connected, turn the camera's main dial to .

-  will display when the printer is correctly connected



- 
- When you detach the cable from the camera, do not forget to press the **PUSH** button while you remove it.



- 
- Please see the Card Photo Printer CP-10 manual for instructions to install paper and ink cartridges.
  - Since the lens will not retract when you switch from  to  after the printer is connected, be careful not to damage the lens. If you wish to retract the lens, detach the direct interface cable from the camera and repeat Step 1.
  - The Following operations cannot be conducted while the printer is connected.
    - Replaying movies
    - Setting the language using the **SET** and **JUMP** button combination.
  - When the printer is disconnected, the  symbol will disappear from the LCD monitor and the camera will revert to standard replay mode.

# Printing

An image can be printed when displayed in single replay or selected in index replay.



**1** Press ◀ or ▶ arrow on the omni selector to choose an image and press the **SET** button.



**2** Set the number of prints, the print style and cropping settings as required.

- Selecting the number of copies (p. 109)
- Setting the Print Style (p. 109)
- Trimming (Printing a Portion of an image) (p. 110)

**3** Press the ▲, ▼, ◀ or ▶ arrows on the omni selector to choose [Print] and press the **SET** button.

- You can also select [Print] by pressing the **JUMP** button.
- The image will start to print and, when it is completely finished, the display will revert to standard replay mode.



- You cannot print movies or images recorded in the RAW format.



## Cancel Printing

- To cancel printing between images, press the **SET** button. A confirmation dialog will display. Press the ◀ or ▶ arrow to select [OK] and press the **SET** button.
- A print in progress cannot be stopped. Wait until the current image is printed and then cancel before the next one starts. The display will revert to standard replay mode.

## Printing Errors

- An error message will display if an error occurs for some reason during the printing process. Press the ◀ or ▶ arrow on the omni selector to choose [Stop] or [Resume] and press the **SET** button.
- The [Resume] option may not appear with some error messages. Select the [Stop] option in that case.

## Selecting the Number of Copies



- 1 In replay mode, press the **SET** button and the **▲** or **▼** arrow on the omni selector to select the [Copies] option.
- 2 Press the **◀** or **▶** arrow on the omni selector to specify the desired number of copies.
  - You can specify from 1 to 99 prints.

## Setting the Print Style

You can select from among the following print styles.

Image	Standard	Prints one image per page.
	Multiple	Prints eight copies of the same image on one page.
Borders	Borderless	Prints right to the edges of the page.
	Bordered	Prints with a border.
Date		Prints the image's creation date.



- 1 In replay mode, press the **SET** button and the **▲** or **▼** arrow on the omni selector to choose [Style] and press the **SET** button again.
- 2 Press the **▲** or **▼** arrow on the omni selector to choose [Image], [Borders] or [Date].
- 3 Press the **◀** or **▶** arrow on the omni selector to set the selection.

### Image

- Choose [Standard] or [Multiple].





Print Area Frame

## Borders

- Choose [Borderless] or [Bordered].

## Date

- Choose [On] or [Off].

## 4 press the **MENU** button to close the settings menu.

- If [Borderless] or [Multiple] is selected as the print style, the center portion of the recorded image (the image displayed in the LCD monitor) is printed at an enlarged size. As a result, the image's top, bottom and sides may be cropped slightly. If you have not specified a trimming setting, a frame will appear around the area of the image that will be printed, allowing you to check the portion that will be cropped.



- The date and borders settings cannot be selected when the [Multiple] option is selected. (The image will be printed with the Date set to [Off] and the Borders set to [Borderless].)
- With the [Bordered] option, the image area remains relatively unchanged from the recorded image when it is printed.

## Trimming (Printing a Portion of an Image)

You can specify which portion of an image gets printed.

### Prior to Trimming

Please set the Print Style (Image, Borders and Date) first before setting the trimming settings (p. 109).



## 1

In replay mode, press the **SET** button and the **▲** or **▼** arrow on the omni selector to choose [Trimming] and press the **SET** button again.

- The trimming frame will appear at the center of the image. If a trimming setting has already been selected for the image, the frame will appear around the selected portion.





## 2 Trim the Image.

### Changing the Size of the Trimming Frame

- Move the zoom lever toward the or symbol.
- The trimming frame can be changed to a minimum selection of approximately half the displayed image or a maximum selection that is virtually the same size as the image.
- You can cancel the trimming setting by moving the zoom lever toward the symbol again when the trimming frame is already set to the maximum size.
- If the image is magnified while in the trimming mode, it will print out more coarsely the greater the degree of magnification. The trimming frame will change to red.

### Setting the Portion of the Trimming Frame

- Press the , , or arrow on the omni selector to move the trimming frame.

### Rotating the Trimming Frame

- You can rotate the trimming frame by pressing the **DISPLAY** button to change its x/y axis.



Trimming Frame

## 3 Press the **MENU** button to close the settings menu.



- The trimming setting only applies to one image.
- The trimming setting is cancelled with the following operations.
  - When you set the trimming settings for another image.
  - When you close the Print mode (when you turn the camera power off, turn the main dial, or detach the DIF-200 direct interface cable).
  - When you try to expand the trimming frame beyond its maximum size.



- The selected Image Settings and Border setting determine the shape of the trimming frame.
- Please use the LCD monitor to set the trimming settings. The trimming frame may not display correctly on a TV monitor.

# Printing with DPOF Print Settings on Card Photo Printer CP-10

You can use the DPOF print settings to print with Card Photo Printer CP-10.

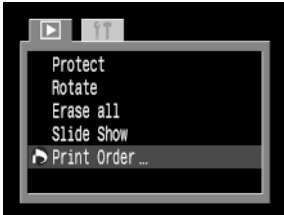

**1** In the [  (Play)] menu, select [Print Order] and press the **SET** button.

- See Selecting Menus and Settings (p. 39).
- The Print Order menu will display.

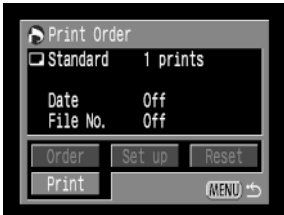

**2** Press the **▲**, **▼**, **◀** or **▶** arrow on the omni selector to select [Print] and press the **SET** button.



**3** Set the print style settings as required.

- See Setting the Print Settings (p. 109).
- A print style cannot be set if the print type is set to [Index].



**4** Press the **SET** button.

- The image will start to print and, when it is completely finished, the display will revert to the standard replay mode.



- To print the date, set the [Date] setting in the print order menu in Step 2 above to [On]. You cannot set the date to print with the [Style] menu in Step 3 above. If the print type is set to [Index], the date will not print even if the [Date] setting is set to [On] in Step 2.
- The file number will not print.



- When the Print Type is set to [Index], 20 images are printed on one page.

### **Cancel Printing**

- To cancel printing between images, press the **SET** button. A confirmation dialog will display. Press the ◀ or ▶ arrow to select [OK] and press the **SET** button.
- A print in progress cannot be stopped. Wait until the current image is printed and then cancel before the next one starts. The display will revert to standard replay mode.

### **Restarting Printing**

- In the Print Order menu, press the ◀ or ▶ arrow on the omni selector to select [Resume] and press the **SET** button. The remaining images can be printed.
- Printing cannot be restarted under the following circumstances.
  - When you set the trimming settings for another image.
  - If the print settings have been changed before restarting.
  - If the image for which the print settings were set has been deleted before restarting.
  - If there was very little free space on the CF card when the printing was cancelled.

If these circumstances apply, you can select [OK] in the Print Order menu and reprint starting from the first image. If printing was cancelled because the camera battery charge became depleted, you are recommended to power the camera with a household power source. If you must use a battery pack, ensure that it is fully charged for printing. After replacing the spent battery pack, turn the camera power on again.

### **Printing Errors**





- An error message will display if an error occurs for some reason during the printing process. Press the ◀ or ▶ arrow on the omni selector to choose [Stop] or [Resume] and press the **SET** button.
- The [Resume] option may not appear with some error messages. Select the [Stop] option in that case.



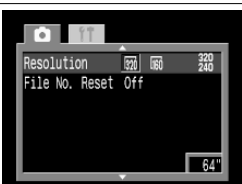

# List of Menu Options

The chart below lists menu items and settings. See *Selecting Menus and Settings* (p. 39) to learn how to select a setting.

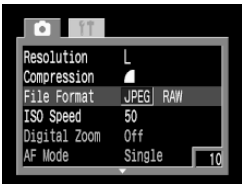
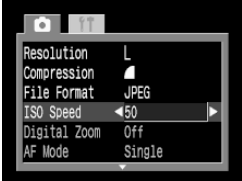
## Rec. Menu

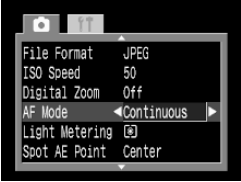
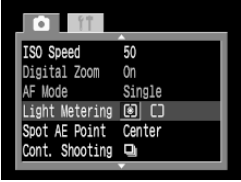

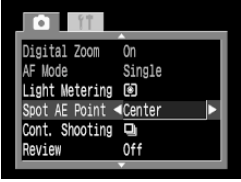
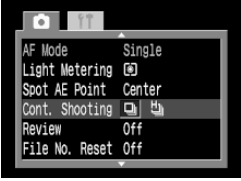

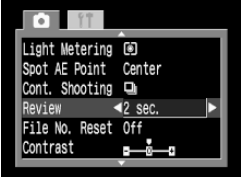

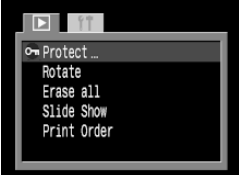

\* Some items may not appear in certain shooting modes (p. 85).

Item	Menu Screen	Settings Content	Reference Page
Resolution (Excluding  )		Sets the number of pixels used to record images to CF cards. <ul style="list-style-type: none"> <li>• <b>L</b> Large (2048 x 1536 pixels)</li> <li>• <b>M1</b> Medium 1 (1600 x 1200 pixels)</li> <li>• <b>M2</b> Medium 2 (1024 x 768 pixels)</li> <li>• <b>S</b> Small (640 x 480 pixels)</li> </ul>	p. 58
Resolution (  )		Sets the resolution of the frames as they are recorded to the CF card. <ul style="list-style-type: none"> <li>• <b>320</b> (320 x 240 pixels)</li> <li>• <b>160</b> (160 x 120 pixels)</li> </ul>	p. 58
Compression		Sets the relative compression ratio used to record images to CF cards. <ul style="list-style-type: none"> <li>• <b>S</b> Superfine</li> <li>• <b>F</b> Fine</li> <li>• <b>N</b> Normal</li> </ul>	p. 58
File Format		Sets the file format used to record images to CF cards. <ul style="list-style-type: none"> <li>• JPEG</li> <li>• RAW</li> </ul>	p. 60
ISO Speed		Sets the sensitivity at which images are recorded. <ul style="list-style-type: none"> <li>• 50</li> <li>• 100</li> <li>• 200</li> <li>• 400</li> <li>• AUTO</li> </ul>	p. 83

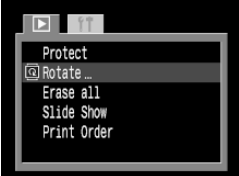

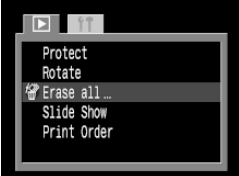

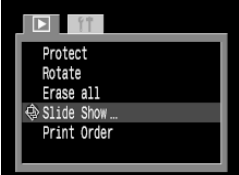

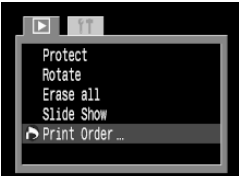











Item	Menu Screen	Settings Content	Reference Page
Digital Zoom		Combines with the optical zoom to zoom images up to an approximate factor of 11. <ul style="list-style-type: none"> <li>• Off</li> <li>• On</li> </ul>	p. 57
AF Mode		Sets the frequency of autofocus activation. When the LCD monitor is off, this setting locks in single mode. <ul style="list-style-type: none"> <li>• Continuous</li> <li>• Single</li> </ul>	p. 82
Light Metering		Switches between two metering options. <ul style="list-style-type: none"> <li>•  (Evaluative Metering)</li> <li>•  (Center-Weighted Averaging)</li> </ul>	p. 78
Spot AE Point		Sets the point at which the camera meters when the spot metering option is selected. <ul style="list-style-type: none"> <li>• Center</li> <li>• AF Point</li> </ul>	p. 79
Cont. Shooting		Sets the continuous shooting option. <ul style="list-style-type: none"> <li>• </li> <li>• </li> </ul>	p. 55
Review		Sets the duration images display on the LCD monitor after the shutter button is released. <ul style="list-style-type: none"> <li>• Off</li> <li>• 2 sec.</li> <li>• 10 sec.</li> </ul>	p. 42

Item	Menu Screen	Settings Content	Reference Page
File No. Reset		Sets how file numbers are assigned to images when new CF cards are inserted. <ul style="list-style-type: none"> <li>• On</li> <li>• Off</li> </ul>	p. 84
Contrast		Adjusts the image contrast. <ul style="list-style-type: none"> <li>• -</li> <li>• 0</li> <li>• +</li> </ul>	p. 83
Sharpness		Adjusts the image sharpness. <ul style="list-style-type: none"> <li>• -</li> <li>• 0</li> <li>• +</li> </ul>	p. 83
Saturation		Adjusts the image saturation. <ul style="list-style-type: none"> <li>• -</li> <li>• 0</li> <li>• +</li> </ul>	p. 83



# Play Menu

Item	Menu Screen	Settings Content	Reference Page
 Protect...		Protects images from accidental erasure.	p. 96
 Rotate...		Rotates images 90 or 270 degrees clockwise in the display.	p. 91
 Erase all...		Erases all images from a CF card (excluding protected images).	p. 98
 Slide Show...		Plays images in an automated slide show.	p. 92
 Print Order...		Sets the images that will be printed on a DPOF-compatible printer or at a photo lab service, the number of copies and other parameters.	p. 100

# Set up Menu

Item	Menu Screen	Settings Content	Reference Page
Beep		Sets whether or not the beep sounds when the shutter button is pressed or when a menu operation is performed. <ul style="list-style-type: none"> <li>• On</li> <li>• Off (Still beeps to warn of an error even when set to Off)</li> </ul>	p. 36
LCD Brightness		Sets the brightness level of the LCD monitor. <ul style="list-style-type: none"> <li>•  (Normal)</li> <li>•  (Bright)</li> </ul>	—
Shutter Volume (Shooting)		Adjusts the sound volume when the shutter button is pressed all the way. The beep does not sound while a movie is being shot. <ul style="list-style-type: none"> <li>•  (Off)</li> <li>•  (1)</li> <li>•  (2)</li> <li>•  (3)</li> <li>•  (4)</li> <li>•  (5)</li> </ul>	p. 36
Playback Vol. (Replay)		Adjusts the sound volume when a movie is played. <ul style="list-style-type: none"> <li>•  (Off)</li> <li>•  (1)</li> <li>•  (2)</li> <li>•  (3)</li> <li>•  (4)</li> <li>•  (5)</li> </ul>	p. 90
Auto Power Down		Sets whether or not the camera automatically powers down after a specified period of time elapses without something being pressed. <ul style="list-style-type: none"> <li>• On</li> <li>• Off</li> </ul>	p. 30

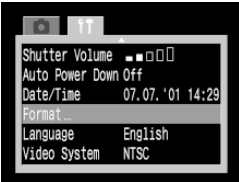



Item	Menu Screen	Settings Content	Reference Page
Date/Time...		Sets the date, time and date format.	p. 26
Format...		Formats (initializes) a CF card.	p. 99
Language...		<p>Sets the language used in the menus and messages on the LCD monitor.</p> <ul style="list-style-type: none"> <li>• English</li> <li>• Deutsch</li> <li>• Français</li> <li>• Nederlands</li> <li>• Dansk</li> <li>• Suomi</li> <li>• Italiano</li> <li>• Norsk</li> <li>• Svenska</li> <li>• Español</li> <li>• Chinese</li> <li>• Japanese</li> </ul> <p>You can change the language during image replay by holding the <b>SET</b> button and pressing the <b>JUMP</b> button.</p>	p. 27
Video System		<p>Sets the video output signal standard.</p> <ul style="list-style-type: none"> <li>• NTSC</li> <li>• PAL</li> </ul>	-

# Shooting / Replaying with a TV Monitor

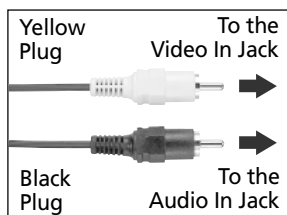
A video-compatible television connected via the supplied AV cable AVC-DC100 can be used to view images as you shoot or replay them.



- 1 Turn the main dial to **OFF** and confirm that the TV is turned off.
- 2 Attach AV cable AVC-DC100 to the AV OUT terminal on the camera.
- 3 Plug the other ends of the AV cable to the video in and audio in jacks on the TV.
- 4 Turn on the TV and switch it to Video mode.
- 5 Turn the camera's main dial to  or .
  - The image will appear on the TV. Shoot or replay images as usual.
  - If the images are not appearing on the TV when shooting, press the **DISPLAY** button.



- No image will display in the LCD monitor when the camera is connected to a TV monitor.
- The video output signal can be switched (NTSC or PAL) to accommodate different regional standards (p. 119). The default setting will vary between regions.
  - NTSC: Japan, U.S.A., Canada, Taiwan, etc
  - PAL: Europe, Asia (Excluding some areas), Oceania, etc
- You can plug the AV cable into either the left or right input jack on the TV. Please consult the TV's manual for details.
- A TV monitor cannot be used in  mode.

# Using the Wireless Controller

## Installing the Battery

Install the date battery (CR2025) into Wireless Controller WL-DC100 before use.



- Be particularly careful to keep the date batteries out of the reach of children. Seek medical assistance immediately if a child swallows a battery since corrosive battery fluids could damage the stomach or intestinal wall.

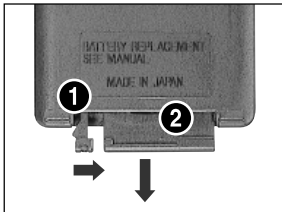

**1** Place your fingertip on **1** and press it in the direction of the arrow while placing another fingertip on **2** and removing the battery holder.

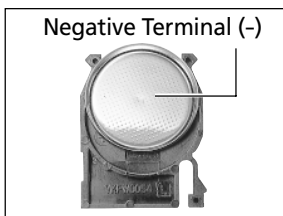

**2** Place the date battery in the battery holder with the negative terminal (-) facing up.

**3** Replace the battery holder into the wireless controller.

## Removing the Battery



To remove the date battery, pull it in the direction of the arrow.

If you ever dispose of your camera, first remove the date battery for recycling according to the recycling system of your country.



# Shooting / Replaying

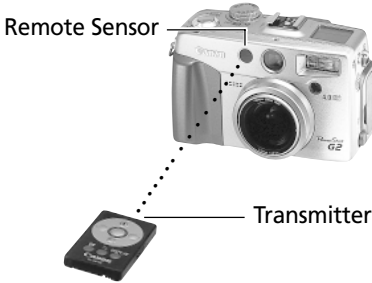

The wireless controller can be used to shoot or replay. The wireless controller can be operated from an approximate distance of up to 5 m (16.4 ft.) from the remote sensor.

## Shooting

Press the button on the camera until the icon appears in the display panel, then replay with the wireless controller.



- (1) Compose the image with the zoom buttons.
- (2) Press the shutter button.  
The camera will shoot the image 2 seconds later.
- Each press of this button cycles the LCD monitor to the next display mode. The order is LCD monitor on (no display), LCD monitor on (detailed display) and LCD monitor off.

## Replaying

The icon appears in the display panel.

- Display the previous image
- Replay the movie images
- Display the next image
- In magnified mode, these buttons move the magnified area around the image.
- In index replay, these buttons move the image selection.
- The display mode changes with each press of the button.
- The display cycles between magnifications of approximately 3 or 6.
- Display images in sets of nine (index replay).



- The operable range of the wireless controller will shorten under the following circumstances.
  - When the wireless controller is used at an angle to the remote sensor.
  - When strong light strikes the camera.
  - When the battery is weak.
- The remote sensor may be blocked when Macro Ring Lite MR-14EX is attached to the camera, preventing the use of the wireless controller.



# Using an Externally Mounted Flash (Optional)

You can make your flash photography even clearer and more natural appearing with the use of a separately sold externally mounted flash. The camera's auto exposure function will operate with a Canon Speedlite 220EX, 380EX, 420EX, 550EX or a Macro Ring Lite MR-14EX (p. 125). Other flashes may fire at full intensity or not fire at all. Please check the manual for your flash.







- Certain functions noted in the manuals for the Canon Speedlite 220EX, 380EX, 420EX, 550EX and Macro Ring Lite MR-14EX cannot be performed when mounted on this camera. Please read this guide before using one of these flashes on the camera.



Speedlite 420EX Mounted on the Hot Shoe

- 1 Attach the flash to the camera's hot shoe.
- 2 Turn the external flash on and turn the camera's main dial to .
- 3 Turn the mode dial to a mode other than  or .

## Speedlite 220EX, 380EX, 420EX, 550EX or Macro Ring Lite MR-14EX

- The flash will automatically adjust its output in the **AUTO**, , , , , , , **Tv** and **Av** modes. The maximum flash synchro shutter speed is 1/250 second.
- The maximum flash synchro shutter speed in the **M** mode is 1/250 second. Set the aperture to an appropriate value according to the flash's guide number and the distance to the subject. Check the camera's ISO sensitivity setting since the flash's guide number will change with the ISO value. In **M** mode, the output of an externally mounted flash can be adjusted with the flash exposure compensation bar (p. 74). When a Speedlite 550EX or Macro Ring Lite MR-14EX is mounted on the camera, you can adjust the flash output from either the flash or the camera. To set it from the flash, you are

recommended to use the flash's manual mode. You can also adjust the flash output even when the camera is set to the E-TTL automatic flash exposure compensation mode by changing the flash exposure compensation setting. In this situation, the +2 step setting fires the flash at full intensity.

To shoot with the flash, you are recommended to set the white balance to the WB (Flash) setting.

### Other Canon Flashes



- Since other flashes fire at full strength, set the shutter speed and aperture accordingly. Set the shutter speed to 1/250 second (maximum flash synchro shutter speed) or slower, and set the aperture to a value appropriate to the flash's guide number and the distance to the subject. You are recommended to set the white balance to WB (Flash) to shoot.

## 4 Press the shutter button halfway to focus.

- The flash is charged when its pilot lamp lights up.

## 5 Press the shutter button all the way to shoot the image.



- The flash will not fire in ,  or continuous mode.
- The AEB mode cannot be used for flash photography. If the flash fires, only one image gets recorded.
- Please note that proprietary high-voltage flashes with multi contacts or flash accessories made by other manufacturers may cause a camera malfunction.



- The following functions can be used with a Speedlite 220EX, 380EX, 420EX or 550EX.
  - Auto Exposure (Use the E-TTL mode with a 550EX)
  - FE Lock (Not available in **M** mode)
  - Daylight Synchro
  - Slow Synchro
  - Flash Exposure Compensation (When Speedlite 550EX is used, the 550EX's flash exposure compensation setting takes precedence when the flash is set to E-TTL mode and a flash exposure compensation value other than 0 is set. The camera's flash exposure compensation setting will not activate unless the 550EX's flash exposure compensation is set to 0.)
  - Auto Zoom (Not available with the 220EX)

## How to Mount Macro Ring Lite MR-14EX

The separately sold Conversion Lens Adapter LA-DC58 and the Macro Lite Adapter 58C are required to mount Macro Ring Lite MR-14EX on the camera.



**1** Remove the outer ring on the lens.



**2** Attach Conversion Lens Adapter LA-DC58 by turning it in the direction of the arrows.

- If you plan to attach Close-up Lens 250D (p. 128), do it after you attach this adapter.



**3** Attach Macro Lite Adapter 58C by turning it in the direction of the arrows.



**4** Attach the controller to the camera's hot shoe.



**5** Press and hold the clips on both sides of Macro Ring Lite MR-14EX and fit it into Macro Lite Adapter 58C.

**6** Press the  button.



- Shoot from a distance of at least 20 cm (8 in.) from the subject in macro mode. To shoot closer up, use the **Av** or **M** mode and set the aperture to a higher value.
- When you are using Macro Ring Lite MR-14EX, you can shoot in E-TTL automatic flash exposure compensation mode just by setting the camera's shooting mode to **P**, **Tv** or **Av**. You are recommended to use the **Av** mode for full-fledged macro flash photography. Since the aperture cannot be set freely in **Tv** mode, it is not recommended.
- The following functions can be used with Macro Ring Lite MR-14EX mounted.
  - E-TTL Automatic Flash Exposure Compensation
  - FE Lock
- When Macro Ring Lite MR-14EX is used, the MR-14EX's flash exposure compensation setting takes precedence when the flash is set to E-TTL mode and a flash exposure compensation value other than 0 is set. The camera's flash exposure compensation setting will not activate unless the MR-14EX's flash exposure compensation is set to 0.



# Using Conversion Lenses (Optional) / Close-up Lenses (Optional)

The separately sold Conversion Lens Adapter LA-DC58 is required to use conversion and close-up lenses with the camera, such as the separately sold Wide Converter WC-DC58, Tele-converter TC-DC58 and Close-up Lens 250D (58 mm).



- Ensure that the wide converter, tele-converter and close-up lens are firmly screwed onto the adapter. Injury from glass shards can occur if the lens loosen and fall off.
- Never aim the wide converter, tele-converter or close-up lens directly at the sun or bright lights.

## Wide Converter WC-DC58



This 58 mm-threaded diameter magnifying conversion lens is for taking wide angle shots. The lens changes the focal length of the camera body's lens by a factor of 0.8x.

## Tele-converter TC-DC58



This 58 mm-threaded diameter magnifying conversion lens is for taking telephoto shots. The lens changes the focal length of the camera body's lens by a factor of 1.5x.



- An externally mounted flash may not automatically adjust its output when a conversion lens is mounted on the camera. You may have to set the camera to manual mode and set the shutter speed and aperture to appropriate settings in this case.
- Do not attach filters or lens hoods to the wide converter or tele-converter.
- When using the built-in flash to shoot, a portion of the image may be blocked by the wide converter or tele-converter and appear dark.
- When using the viewfinder to shoot, a portion of the image in the viewfinder may appear to be blocked by the wide converter or tele-converter.
- Use the wide converter lens with the focal length set to the maximum wide angle setting.
- Use the tele-converter lens with the focal length set to the maximum telephoto setting. At other zoom settings, the image will not appear correctly.

## Close-up Lens 250D (58 mm)



This lens with a 58 mm-threaded diameter makes macro shooting easier. With the camera in macro mode, it can shoot subjects in the range of 12 to 20 cm (4.7 to 7.9 in) from the lens tip.



- You are recommended to use Macro Ring Lite MR-14EX for flash photography with the close-up lens mounted on the camera.
- Set the focal length of the camera's lens to telephoto when using the close-up lens.

## Mounting the Lenses



- 1 Remove the ring from around the lens on the camera body.



- 2 Screw on Conversion Lens Adapter LA-DC58 in the direction of the arrows.



- 3 Screw on the lens in the direction of the arrows.

Wide-Converter WC-DC58  
mounted



- 
- Since the image seen in the viewfinder does not change when a conversion lens is installed, use the LCD monitor to compose images.
  - Please note that the images will not merge properly with the PhotoStitch program on a computer when they are shot in  mode with a conversion or close-up lens.
  - To protect the conversion lenses, hold them with one hand while you screw them on with the other hand.
  - Completely remove all dust and dirt from conversion lenses with a lens blower brush before use. The camera may focus on any dirt that remains.
  - Exercise due caution when handling the conversion lenses since it is easy to dirty them with fingerprints.

# Appendices

## Replacing the Date Battery

If the Set Date/Time menu appears when you turn on the camera power, the date battery charge is low and the date and time settings have been lost. Please replace the battery with a generic CR2016 lithium coin battery with the following procedures.

Please note that the first date battery may appear to expire relatively quickly after you purchase the camera. This is because it is installed in the camera at the point of manufacture, not when you make the purchase.



- Be particularly careful to keep the date batteries out of the reach of children. Seek medical assistance immediately if a child swallows a battery since corrosive battery fluids could damage the stomach or intestinal wall.

**1** Turn the main dial to **OFF**.

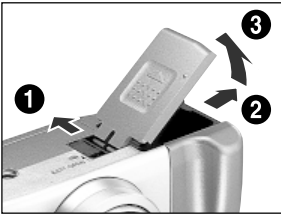

**2** Slide the battery cover lock in the direction of the arrow and push the battery cover open.

**3** Remove the battery pack.

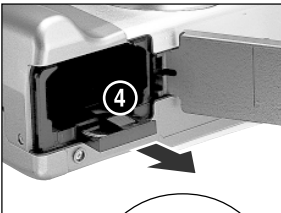

**4** Push point **4** with your fingertip while pulling the date battery holder out to remove it.

**5** Insert a fingernail into the groove in the date battery and push it out in the direction of the arrow.

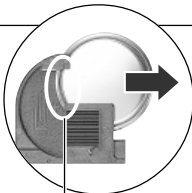

Groove

Negative Terminal (-)

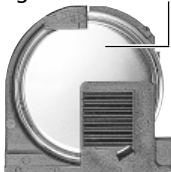

- 6** Place a new date battery into the date battery holder with the negative terminal (-) facing upward.
- 7** Replace the date battery holder, replace the battery pack and close the battery cover.

If you ever dispose of your camera, first remove the date battery for recycling according to the recycling system of your country.



# Camera Care and Maintenance

Use the following procedures to clean the camera body, lens, viewfinder, LCD monitor and other parts.

---



Camera body	Wipe the body clean with a soft cloth or eyeglass lens wiper.
Lens	First use a lens blower brush to remove dust and dirt, then remove any remaining dirt by wiping the lens lightly with a soft cloth. <ul style="list-style-type: none"><li>• Never use synthetic cleansers on the camera body or lens. If dirt remains, contact the nearest Canon Customer Support Help Desk (see the back of this guide).</li></ul>
Viewfinder / LCD monitor	Use a lens blower brush to remove dust and dirt. If necessary, gently wipe the viewfinder and LCD monitor with a soft cloth or an eyeglass lens wiper to remove stubborn dirt. <ul style="list-style-type: none"><li>• Never rub or press forcefully on the LCD monitor. These actions may damage it or lead to other problems.</li></ul>





---



- Never use thinners, benzene, synthetic cleansers or water to clean the camera. These substances may distort or damage the equipment.

# Troubleshooting

Problem	Cause	Solution
Camera will not operate	Power is not turned on	<ul style="list-style-type: none"> <li>Turn the main dial to a position other than <b>OFF</b>.</li> </ul>
	Battery cover or CF card slot cover is open	<ul style="list-style-type: none"> <li>Confirm that the battery cover is securely closed.</li> <li>Confirm that the CF card slot cover is securely closed.</li> </ul>
	Insufficient battery voltage ([Lb] flashes in display panel)	<ul style="list-style-type: none"> <li>Fully charge the battery or use a household power source.</li> </ul>
	Poor contact between camera and battery terminals	<ul style="list-style-type: none"> <li>Wipe the terminals with a clean, dry cloth.</li> </ul>
Camera will not record	Main dial is set to <b>OFF</b> or  (Replay)	<ul style="list-style-type: none"> <li>Turn the main dial to  (Shooting).</li> </ul>
	Flash is charging (flashing orange indicator)	<ul style="list-style-type: none"> <li>Wait until the orange indicator stops flashing and shines steadily, signaling that the flash is charged, then press the shutter button.</li> </ul>
	CF card full	<ul style="list-style-type: none"> <li>Insert a new CF card.</li> <li>If required, download the images to a computer and erase them from the CF card to make space.</li> </ul>
	CF card not formatted correctly	<ul style="list-style-type: none"> <li>Format CF card. → See Formatting a CF card (p. 99)</li> <li>If reformatting doesn't work, the CF card logic circuits may be damaged. Contact the nearest Canon Customer Support Help Desk.</li> </ul>
Lens will not retract	Battery cover or CF card slot cover opened immediately after main dial turned to <b>OFF</b>	<ul style="list-style-type: none"> <li>Close the battery cover or CF card slot cover, and then turn the main dial on and back to <b>OFF</b>.</li> </ul>
	Battery cover or CF card slot cover opened while camera was recording to the CF card (warning signal)	<ul style="list-style-type: none"> <li>Close the battery cover or CF card slot cover, and then turn the main dial to <b>OFF</b>.</li> </ul>
Battery pack consumed quickly	Battery pack capacity reduced because of disuse for one year or more after being fully charged	<ul style="list-style-type: none"> <li>Replace the battery pack with a new one.</li> </ul>
	Battery life exceeded	
Battery pack will not charge	Main dial is not turned to <b>OFF</b>	<ul style="list-style-type: none"> <li>Turn the main dial to <b>OFF</b>.</li> </ul>
	Battery life exceeded	<ul style="list-style-type: none"> <li>Replace the battery pack with a new one.</li> </ul>
	Poor contact between camera and compact power adapter	<ul style="list-style-type: none"> <li>Plug the compact power adapter's DC plug more firmly into the camera's DC IN terminal.</li> <li>Connect the power cord to the compact power adapter and insert its plug firmly into the electrical outlet.</li> </ul>

Problem	Cause	Solution
Image is blurred or out of focus	Camera moved	<ul style="list-style-type: none"> <li>• Be careful not to move the camera when pressing the shutter button.</li> <li>• Use a tripod at slow shutter speeds when the camera shake warning  displays.</li> </ul>
	Autofocus function hampered by obstruction to AF auxiliary light emitter	<ul style="list-style-type: none"> <li>• Be careful not to block the AF auxiliary light emitter with your finger or other items.</li> </ul>
	Subject out of focal range	<ul style="list-style-type: none"> <li>• Ensure that there is at least 70 cm (2.3 ft.) between the camera lens and subject.</li> <li>• Use the macro mode to shoot close-ups between 6 and 70 cm (2.4 in. and 2.3 ft.) at maximum wide angle and 20 and 70 cm (7.9 in. and 2.3 ft.) at maximum telephoto.</li> </ul>
Subject in recorded image is too dark	Insufficient light for shooting	<ul style="list-style-type: none"> <li>• Set the built-in flash to on.</li> <li>• Use a high-output externally mounted flash.</li> </ul>
	Subject dark in comparison to the background	<ul style="list-style-type: none"> <li>• Set the exposure compensation to a positive (+) setting.</li> <li>• Use the AE lock or spot metering function.</li> </ul>
	Subject too far for flash to reach	<ul style="list-style-type: none"> <li>• To use the built-in flash, shoot within 70 cm to 4.5 m (2.3 to 14.8 ft.) of the subject at the maximum wide angle and within 70 cm to 3.6 m (2.3 to 11.8 ft.) at the maximum telephoto setting.</li> <li>• Use an externally mounted flash with a large output.</li> </ul>
Subject in recorded image is too bright	Subject too close (flash photography)	<ul style="list-style-type: none"> <li>• Adjust the flash output with the flash exposure compensation function (p. 74).</li> </ul>
	Subject bright in comparison to the background	<ul style="list-style-type: none"> <li>• Set the exposure compensation to a negative (-) setting.</li> <li>• Use the AE lock or spot metering function.</li> </ul>
	Light shining directly on subject or reflected off subject into camera	<ul style="list-style-type: none"> <li>• Change the shooting angle.</li> </ul>
	Flash set to On	<ul style="list-style-type: none"> <li>• Set the flash to Auto or Off.</li> </ul>
Flash will not fire	Flash set to Off	<ul style="list-style-type: none"> <li>• Set the flash to Auto or On.</li> </ul>
Image not showing on TV	Main dial is set to <b>OFF</b>	<ul style="list-style-type: none"> <li>• Turn the main dial to  (Shooting) or  (Replay).</li> </ul>
	Incorrect video system setting	<ul style="list-style-type: none"> <li>• Set the video system to the appropriate setting, NTSC or PAL, for your TV → (See Set up Menu, p. 119).</li> </ul>
Zoom does not operate	Mode dial is turned to 	<ul style="list-style-type: none"> <li>• Turn the mode dial to any shooting mode except for .</li> </ul>
	Zoom lever was pressed while shooting in movie mode	<ul style="list-style-type: none"> <li>• Operate the zoom before shooting in movie mode.</li> </ul>



# List of Error / Message Codes

The following error and message codes may appear on the display panel.

## Error Codes

---

**Exx:** (xx: number) The camera has experienced a problem. Turn the main dial to **OFF**, wait a second, and then try shooting or replaying. If the error code appears repeatedly, there is a problem. Note the error code number and take the camera in for servicing. If an error code appears immediately after a shot, there is a chance that the image was not recorded. Check the image in replay mode.

---

## Message Codes

---

**Pb:** Replaying image.

---

**PC:** Connected to computer in PC connection mode.

---

: Adequate battery charge.

---

: Low battery charge. Charge the battery as soon as possible to use for any length of time.

---

  
**Lb**: Battery charge low, camera will not operate. Immediately recharge or replace the battery pack with a charged one.  
Could also indicate that the battery cover is open. Close the cover securely.

---

**CF:** No CF card in camera, CF card slot cover is open, or CF card error.

---

**LENS:** Power turned on with lens cap on. Remove cap, then turn power off and on again.

---

# List of Messages

The following messages may appear on the LCD monitor.

---

Busy...	Image is being recorded to, or read from, CF card.
No CF card:	You attempted to shoot or replay images without a CF card installed.
Cannot record!:	You attempted to shoot an image without a CF card installed.
CF card error!:	CF card has experienced an anomaly.
CF card full:	CF card is too full to accommodate more images or print settings.
Naming error!:	The file could not be created because there is a file with the same name as the directory that the camera is attempting to create, or the highest possible file number has already been reached. In the Rec. menu, please set [File No.] Reset to [On]. After you save all the images you wish to retain onto a computer, format the CF card (p. 99). Please note that formatting will erase all the existing images and other data.
No image:	No images recorded on CF card.
Image too large:	You attempted to replay an image larger than 3200 x 2400 pixels or an image or movie shot by another camera.
Incompatible JPEG format:	You attempted to replay an incompatible JPEG file.
Corrupted data:	You attempted to replay an image with corrupted data.
RAW:	You attempted to replay an image recorded in an incompatible RAW format.
Cannot magnify!:	You attempted to magnify an image that was photographed with another camera, recorded in a different format, or edited on a computer.
Cannot rotate:	You attempted to rotate an image that was photographed with another camera, recorded in a different format, or edited on a computer.

---



Unidentified Image:	You attempted to replay an image that was recorded in a special format (proprietary format used by the camera of another manufacturer, etc.), or to replay a movie shot in another camera.
Protected!:	You attempted to erase a protected image.
Too many marks:	Too many images have been marked for printing or for inclusion in a slide show. Cannot process any more.
Cannot mark image:	You attempted to set the print settings for a non-JPEG file.
Cannot complete!:	Couldn't save the print or slide show settings.
Cannot edit:	Slide show settings file is corrupted

**The following message may appear on the camera's LCD monitor when Card Photo Printer CP-10 is printing.**

No Paper:	Paper cassette is incorrectly inserted or out of paper. Or the paper feed isn't operating correctly.
No Ink:	The ink cartridge has not been inserted or has run out of ink.
Ink Cassette Error:	The ink cassette is experiencing a problem.
Paper Jam:	The paper jammed during printing.
Communication Error:	The printer is experiencing a data transmission error.
Cannot trim:	You attempted to trim an image from another camera, one recorded in a different format, or one that has been edited on a computer.
Readjust trimming:	You attempted to print the image with a different style than the one used when the trimming settings were set.
Cannot Print!:	You attempted to print an image from another camera, one recorded in a different format, or one that has been edited on a computer.
Could not print xx images:	You attempted to use the DPOF print settings to print xx images that are from another camera, that have been recorded in a different format, or that have been edited on a computer.

# Specifications

<b>PowerShot G2</b>	
Image sensor:	Approx. 4-million-pixel (effective)/1/1.8 inch CCD Approx. 4.1 million pixels (total)
Lens:	7 (W) - 21 (T) mm (35mm film equivalent: 34 - 102mm) F 2.0 (W) - 2.5 (T)
Digital zoom	Up to approx. 3.6 times (Up to approximately 11 times in combination with the optical zoom)
Optical viewfinder:	Real-image optical zoom viewfinder Field of view approx. 84%
LCD monitor:	1.8 inch, low-temperature polycrystalline silicon TFT color LCD/Field of view approx. 100%
Autofocus method:	TTL autofocus (continuous or single) Focus lock and Manual focus are available
Focusing points:	Switchable (Center or 3 selectable positions)
Focusing range: (from tip of the lens barrel)	Normal AF: 70 cm (2.3 ft.) - ∞ Macro AF: 6 cm (W) / 20 cm (T) - 70 cm (2.4 in. (W) / 7.9 in. (T) - 2.3 ft.) Manual focus: 6 cm (W) / 20 cm (T) - ∞ (2.4 in. (W) / 7.9 in. (T) - ∞)
Shutter:	Mechanical shutter + electronic shutter
Shutter speeds:	15 - 1 / 1000 sec. 1.3 sec. or slower shutter speeds are available in Shutter-Priority mode or Manual mode High-speed shutter setting of 1/1000 sec. is available only at F8 aperture setting Slow shutter speeds of 1.3 sec. or more operates with noise reduction
Light metering method:	Evaluation, Center-weighted averaging or Spot (Center or AF Point)
Exposure control method:	Program AE, Shutter-priority AE, Aperture-priority AE or Manual exposure control AE lock is available
Exposure compensation:	± 2.0EV (in 1/3-stop increments) Auto exposure bracketing (AEB) is available
Sensitivity (equivalent film speed) :	Auto, ISO 50, ISO 100, ISO 200 and ISO 400 equivalent (In Auto mode, camera automatically adjusts sensitivity in the range of ISO 50 to ISO 100 equivalent)
White balance:	TTL auto white balance, pre-set white balance (available settings: Daylight, Cloudy, Tungsten, Fluorescent, Fluorescent H or Flash) or Custom white balance

Built-in flash:	Operating modes: Red-eye reduction auto, Auto, Red-eye reduction On, On or Off Flash range: 70 cm - 4.5 m (2.3 ft. - 14.8 ft.) (W), 70 cm - 3.6 m (2.3 ft. - 11.8 ft.) (T) (When sensitivity is set to ISO 100 equivalent)
Terminals for external flash:	Sync-terminals at accessory shoe Use of following external flashes is recommended: Canon Speedlite 220EX, 380EX, 420EX, 550EX and Macro Ring Lite MR-14EX
Flash exposure compensation:	±2.0 EV (in 1/3-stop increments), FE lock selectable
Shooting modes:	Auto Creative zone: Program, Shutter speed priority, Aperture priority and Manual Image zone: Pan-focus, Portrait, Landscape, Night scene, Color Effect, Stitch Assist and Movie
Continuous shooting:	 : Approx. 1.5 image/sec.  : Approx. 2.5 image/sec. (Large / Fine mode with LCD viewfinder off)
Self-timer:	Activates shutter after a 10-sec. delay
Wireless control:	Shooting and playback are available (wireless controller is included in the camera kit) When shooting, image is captured 2 seconds after shutter button pressed
PC-connected shooting:	Available (Exclusive software program is included in the camera kit)
Storage media:	CompactFlash™ (CF) card (Type I and Type II)
File format:	Design rule for Camera File system, DPOF-compliant
Image recording format:	Still images: JPEG or RAW Movies: AVI (Image data: Motion JPEG, Audio data: WAVE [monaural])
JPEG compression mode:	Super fine, Fine or Normal
Number of recording pixels:	Still images: Large: 2272 x 1704 pixels Medium 1: 1600 x 1200 pixels Medium 2: 1024 x 768 pixels Small: 640 x 480 pixels Movie: 320 x 240 pixels (approx. 30 sec)* 160 x 120 pixels (approx. 120 sec)* Approx. 15 frames/second • The figures in brackets represent the maximum length of one movie clip.
Playback modes:	Single, Index (9 thumbnail images), Magnified (approx. 3x or 6x on built-in LCD monitor), Slide show or Image output to direct printer (CP-10)

Languages:	12 languages available for menus and messages (English, German, French, Dutch, Danish, Finnish, Italian, Norwegian, Swedish, Spanish, Chinese and Japanese)
Interface:	Universal Serial Bus (USB), Audio/Video Output (NTSC or PAL selectable, monaural audio)
Power source:	<ol style="list-style-type: none"> <li>1. Rechargeable Lithium-ion battery (type: BP-511) (included in the camera kit/optional)</li> <li>2. Rechargeable Lithium-ion battery (type: BP-512) (optional)</li> <li>3. AC adapter (included in the camera kit)</li> <li>4. Car battery adapter (Optional Charge Adapter / Car Battery Cable Kit CR-560 is required)</li> </ol>
Operating Temperatures:	0 - 40° C (32 - 104° F)
Operating Humidity:	10 - 90 %
Dimensions (w x h x d):	120.9 x 76.6 x 63.8 mm (4.8 x 3.0 x 2.5 in.) excluding protrusions
Weight:	Approx. 425 g (15 oz.) (camera body only)

### Battery Pack BP-511/Battery Pack BP-512 (Optional)

Type:	Rechargeable lithium ion cell
Nominal voltage:	7.4 V
Nominal capacity:	1100 mAh
Charge cycles:	Approx. 300
Operating temperatures:	0 - 40° C (32 - 104° F)
Dimensions:	38 x 55 x 21 mm (1.5 x 2.2 x 0.8 in.)
Weight:	Approx. 70 g (2.5 oz.)

### Compact Power Adapter CA-560

Input voltage	AC 100-240 V (50/60 Hz) 60 VA (100 V) - 75 VA (240 V)
Rated output:	9.5 V / 2.7 A
Operating temperatures:	0 - 40° C (32 - 104° F)
Dimensions:	57 x 28 x 104 mm (2.2 x 1.1 x 4.1 in.) (camera body only)
Weight:	Approx. 180 g (6.3 oz.)

### Wireless Controller WL-DC100

Power supply:	Lithium button battery CR2025
Operating temperatures:	0 - 40° C (32 - 104° F)
Dimensions:	35 x 6.5 x 56.6 mm (1.4 x 0.3 x 2.2 in.)
Weight:	Approx. 10 g (0.4 oz.)

### CompactFlash™ Card



Card slot type:	Type I
Dimensions:	36.4 x 42.8 x 3.3 mm (1.4 x 1.7 x 0.1 in.)
Weight:	Approx. 10 g (0.4 oz.)

### Charge Adapter / Car Battery Cable Kit CR-560 (Optional)

#### • Charge Adapter CG-560

Input voltage:	DC 9.5 V (when CA-560 used) DC 12/24 V (when automotive battery used)
Input current:	DC 2.5 A (when charging the battery pack)
Nominal output:	DC 8.4 V 1.6 A (when charging the battery pack) DC 9.5 1.5 A (as an adapter)
Operating temperatures:	0 - 40° C (32 - 104° F)
Dimensions:	93 x 36 x 71 mm (3.7 x 1.4 x 2.8 in.)
Weight:	Approx. 140 g (5.0 oz.)

#### • Car Battery Cable CB-560

Supported vehicles:	Cigarette lighter socket powered by a negative ground, DC 12 V or 24 V car battery
Fuse:	125 V / 4 A  
Length:	Approx. 1.8 m (6.0 ft.)
Weight:	Approx. 80 g (2.8 oz.)

### Wide Converter WC-DC58 (Optional)

Magnification:	Approx. 0.8x
Focal length:	∞
Lens configuration:	3 groups 3 pieces
Focusing range (from tip of lens):	10 mm - ∞ (0.4 in. - ∞) (when attached to a PowerShot G2 at maximum wide angle)
Thread diameter:	58 mm Standard filter threads (Conversion Lens Adapter LA-DC58 is required to install the lens on a PowerShot G2)
Dimensions:	Diameter: 80 mm (3.1 in.) / Length: 40 mm (1.6 in.)
Weight:	Approx. 157 g (5.5 oz.)

### Tele-converter TC-DC58 (Optional)

Magnification:	Approx. 1.5x
Focal length:	$\infty$
Lens configuration:	2 groups 3 pieces
Focusing range (from tip of lens):	400 mm - $\infty$ (1.3 ft. - $\infty$ ) (when attached to a PowerShot G2 at maximum telephoto)
Thread diameter:	58 mm Standard filter threads (Conversion Lens Adapter LA-DC58 is required to install the lens on a PowerShot G2)
Dimensions:	Diameter: 65 mm (2.6 in.) / Length: 37 mm (1.5 in.)
Weight:	Approx. 117 g (4.1 oz.)

### Close-up Lens 250D (58 mm) (Optional)

Focal length:	250 mm
Focusing range (from tip of lens):	120 - 200 mm (4.7 x 7.9 in.) (when attached to a PowerShot G2)
Thread diameter:	58 mm Standard filter threads (Conversion Lens Adapter LA-DC58 is required to install the lens on a PowerShot G2)
Dimensions:	Diameter: 60 mm (2.4 in.) / Length: 12 mm (0.5 in.)
Weight:	Approx. 80 g (2.8 oz.)

### Soft Case SC-PS700 (Optional)

Dimensions:	141 x 100 x 80 mm (5.5 x 3.9 x 3.1 in.) excluding protrusions
Weight:	Approx. 40 g (1.4 oz.)



# Index

## A

AEB Shooting 73  
AE Lock 75  
AF Mode 115  
Aperture 64, 66  
Aperture Priority AE (**Av**) 64  
Auto (**AUTO**) 41  
Auto Replay (Slide Show) 92  
AV Cable 120

## B

Battery  
  Handling 17  
  Household Power Source 20  
  Installation 18  
  Performance 19  
  Recharging 16  
  Status 18  
Beep 118  
Built-In Flash 43

## C

Card Photo Printer CP-10 106  
Care and Maintenance 132  
CF Card  
  Formatting 119  
  Handling 25  
  Inserting 24  
  Recordable Images 25  
Charger Adapter/Car Battery Cable Kit 21  
Close-up Lens 127  
Color Effect () 48  
Color Saturation 83, 116  
Compact Power Adapter 16, 20, 23  
Compression 58, 114  
Continuous Shooting 55  
Contrast 83, 116  
Conversion Lens 127  
Conversion Lens Adapter 125, 128  
Creative Zone 14

## D

Date/Time 26, 119  
Date Battery 130  
Detailed Display Mode 34  
Digital Zoom 38, 57, 115  
Display Panel 15

DPOF 100  
Diopter Adjustment 37

## E

Erasing 97  
  All Images 98, 117  
  Displayed Image 9  
  Single Images 97  
Exposure Compensation 69  
Externally Mounted Flash 123

## F

FE Lock 77  
File Number 84  
Flash  
  Built-In 43  
  Externally Mounted 123  
Flash Exposure Compensation 74  
Focusing  
  Autofocus 41  
  Manual Focus 81  
Focus Lock 80  
Formatting 99

## I

Image Characteristics 83  
Image Zone 14  
Indicator 12  
Information View 33  
ISO Sensitivity 83, 114

## L

Landscape () 47  
Language 119  
LCD Monitor 31  
  Brightness 118  
  Detailed Display Mode 34  
  Magnify 87  
  Rotate 91, 117  
  Simple Display Mode 34  
Lens Cap 28

## M

Macro Mode () 53  
Magnify 87  
Main Dial 13  
Manual Exposure (**M**) 66  
Manual Focus 81

Menu  
  Rec. 114  
  Replay 117  
  Selecting and Setting 39  
  Settings Categories 40  
  Setup 118  
Metering Method 78  
Mode Dial 13  
Movie  
  Replaying 90  
  Shooting (📷) 52

## N

Night Scene (📷) 47  
Number Reset Function 116

## P

Pan Focus (👤) 46  
Playback Volume 118  
Portrait (👤) 46  
Power On/Off 29  
Power Save Function 29, 118  
Print Settings 100  
  Print Style 103  
  Reset 105  
  Selecting Images 100  
Program AE (P) 61  
Protect 96, 117

## R

RAW 60  
Recordable Images 59  
Recording Format 60, 114  
Red-Eye Reduction Function 45  
Replaying 86  
  Index Replay 88  
  Single Replay 86  
  Switching between Sets of 9 Images 89  
  Using a TV 120  
Replay Mode 30  
Rotate 91, 117

## S

Self-Timer 54  
Sharpness 83, 116  
Shooting  
  Image Review 42, 115  
  Using a TV 120  
Shooting Mode 30  
  Aperture Priority AE (Av) 64  
  Auto (AUTO) 41

Landscape 47  
List of Modes 85  
Macro Mode 53  
Manual Exposure (M) 66  
Movie 52  
Night Scene (📷) 47  
Pan Focus (👤) 46  
Portrait (👤) 46  
Program AE (P) 61  
Shutter Speed Priority AE (Tv) 62  
Stitch Assist Mode (📷) 49

Shutter Button

  Pressing Fully 36  
  Pressing Halfway 36

Shutter Volume 118

Shutter Speed 62, 66, 76  
Shutter Speed Priority AE (Tv) 62

Simple Display Mode 34

Slide Show 92, 117

  Play Time 95  
  Repeat 95  
  Selecting Images 94

  Starting 92

Soft Case 28

Stitch Assist Mode (📷) 49

  Composing 49  
  Shooting 50

Strap 28

## T

Tele-converter Lens 127  
Telephoto 38

## V

Video System 119  
Viewfinder 37

## W

White Balance (WB) 70  
Wide Angle 38  
Wide Converter Lens 127  
Wireless Controller  
  Battery Installation 121  
  Replaying 122  
  Shooting 122

## Z

Zooming 38  
  Digital 38, 57, 115

# Canon Customer Support

## **Canon Inc.**

30-2 Shimomaruko 3-chome, Ohta-ku, Tokyo  
146-8501, Japan

## **NORTH AMERICA**

### **Canon U.S.A., Inc.**

Canon Customer Care Center  
Phone (US): 1-800-828-4040 (Available Mon. - Fri., 9 AM to 8 PM Eastern Time)

### **Canon Canada Inc.**

Phone (Canada): 1-800-OK-CANON (1-800-652-2666) (24 hours/day, 7 days/week)

## **EUROPE**

### *Europe, Africa & Middle East*

#### **Canon Europa N.V.**

PO Box 2262, 1180 EG Amstelveen, The Netherlands

#### **Canon (UK) Ltd.**

Helpdesk  
Tel.: 08705 143 723 (Calls may be recorded.) Fax.: 08705 143 340

#### **Canon Communication & Image France S.A.**

Tel : 01.41.30.15.15  
Fax : 01.41.30.15.05

#### **Canon Deutschland GmbH**

Canon-Hotline-Service:  
Customer Support: (02151) 349-555  
Info Desk: (02151) 349-566 Fax: (02151) 349-588

#### **Canon Euro-Photo GmbH**

Customer-Support: (02154) 495-610  
Info Desk: (02154) 495-444 Fax: (02154) 495-333

#### **Canon Italia S.p.A.**

Pronto Canon: 02 8249 2000

#### **Canon Belgium N.V. / S.A.**

Helpdesk: 0900-10627  
Tel.: (02) 722.04.11 Fax: (02) 721.32.74

#### **Canon Luxembourg S.A.**

Tel.: (352) 48 47 961 Fax: (352) 48 47 96232

#### **Canon Nederland N.V.**

Helpdesk: 023 - 5 681 681  
Tel.: 023 - 5 670 123 Fax: 023 - 5 670 124

#### **Canon Danmark A/S**

Phone: +45 44882400 e-mail: helpdesk@canon.dk

#### **Canon España S.A.**

Help Desk: 906 301 255  
Fax: (91) 411 76 65 E-mail: helpdesk1@btlink.net

#### **Canon Norge as**

Tlf. 22 62 93 21 Faks: 22 62 06 15  
E-mail: helpdesk@canon.no

## *Finland*

### **Canon OY**

Puhelin: 010 54420 Fax: 010 544 4571

Help Desk: 0600 0 22606 (14,80 mk/min+pvm) Help Desk: 0600 0 22666 (enint. 40mk/puhelu+pvm)

Sähköposti: helpdesk@canon.fi

### **Canon (Schweiz) AG**

Tel. 01-835-6161 Fax 01-835-6526 Hotline 0900 57 55 20

### **Canon Svenska AB**

Tel: 08-744 85 00 Fax: 08-744 64 65

## *Austria*

### **Canon GmbH**

Oberlaaerstraße 233 A-1100 Vienna

Tel: 01 680 88-0 Fax: 01 680 88-308

## **OCEANIA**

### **Canon Australia Pty. Ltd.**

Info-Line: (02) 9805 2864

### **Canon New Zealand Ltd.**

Info-Line: 0900-522666

## **ASIA**

### **Canon Singapore Pte. Ltd.**

79 Anson Road, #09-01 / 06, Singapore 079906

Phone: (65) 532 4400 Fax: (65) 221 7577

### **Canon Hongkong Co., Ltd.**

9/F, The Hong Kong Club Building, 3A Chater Road, Central, Hong Kong

Phone: 852-2739-0802 Fax: 852-2369-7701

### **Canon Marketing Services**

No.1 Jalan Kilang Timor, #09-00, Pacific Tech Centre, Singapore 159303

Phone: (65) 799 8888 Fax: (65) 273 3317

### **Canon Marketing (Malaysia) Sdn. Bhd.**

Wisma General Lumber, Block D, Peremba Square, Saujana Resort, Section U2, 40150,

Shah Alam, Selangor Darul Ehsan, Malaysia

Phone: (60) 3 744 6000, (60) 3 745 0055

Fax: (60) 3 745 0505

### **Canon Marketing (Thailand) Co., Ltd.**

10th Floor, Bangkok City Tower, 179/34-45 South Sathorn Road, Bangkok 10120, Thailand

Phone: (662) 344 9999 Fax: (662) 344 9910

### **Canon Marketing (Hongkong) Co., Ltd.**

10/F, Mirror Tower, 61 Mody Road, Tsimshatsui East, Kowloon HongKong

Phone: 852-2170-2828 Fax: 852-2723-9684





## **FCC Notice**

### **Digital Camera, Model PC1015**

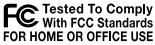

This device complies with Part 15 of the FCC Rules. Operation is subject to the following two conditions;

- (1) this device may not cause harmful interference, and
- (2) this device must accept any interference received, including interference that may cause undesired operation.

Note: This equipment has been tested and found to comply with the limits for Class B digital devices, pursuant to Part 15 of the FCC rules. These limits are designed to provide reasonable protection against harmful interference in a residential installation. This equipment generates, uses and can radiate radio frequency energy and, if not installed and used in accordance with the instructions, may cause harmful interference to radio communications. However, there is no guarantee that interference will not occur in a particular installation. If this equipment does cause harmful interference to radio or television reception, which can be determined by turning the equipment off and on, the user is encouraged to try to correct the interference by one or more of the following measures:

- Reorient or relocate the receiving antenna.
- Increase the separation between the equipment and receiver.
- Connect the equipment into an outlet on a circuit different from that to which the receiver is connected.
- Consult the dealer or an experienced radio/TV technician for help.

The cable with the ferrite core provided with the digital camera must be used with this equipment in order to comply with Class B limits in Subpart B of Part 15 of FCC rules.

Do not make any changes or modifications to the equipment unless otherwise specified in the manual. If such changes or modifications should be made, you could be required to stop operation of the equipment.

**Canon U.S.A. Inc.**

One Canon Plaza, Lake Success, NY 11042, U.S.A.

Tel No. (516) 328-5600

## **Canadian Radio Interference Regulations**

THIS CLASS B DIGITAL APPARATUS MEETS ALL REQUIREMENTS OF THE CANADIAN INTERFERENCE CAUSING EQUIPMENT REGULATIONS.

## **Réglementation canadienne sur les interférences radio**

CET APPAREIL NUMERIQUE DE LA CLASSE B RESPECTE TOUTES LES EXIGENCES DU REGLEMENT SUR LE MATERIEL BROUILLEUR DU CANADA.

**Canon**